

AV Receiver

RX-SL80

OWNER'S MANUAL

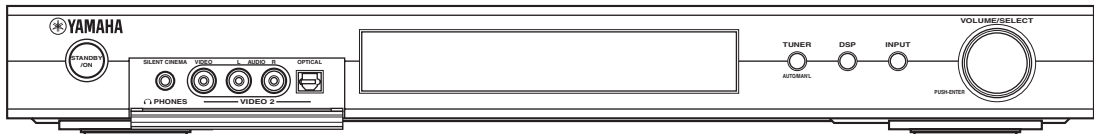

IMPORTANT SAFETY INSTRUCTIONS

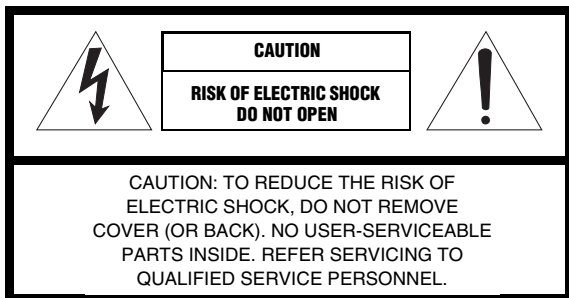

• Explanation of Graphical Symbols



The lightning flash with arrowhead symbol, within an equilateral triangle, is intended to alert you to the presence of uninsulated “dangerous voltage” within the product’s enclosure that may be of sufficient magnitude to constitute a risk of electric shock to persons.



The exclamation point within an equilateral triangle is intended to alert you to the presence of important operating and maintenance (servicing) instructions in the literature accompanying the appliance.

- 1 Read Instructions – All the safety and operating instructions should be read before the product is operated.
- 2 Retain Instructions – The safety and operating instructions should be retained for future reference.
- 3 Heed Warnings – All warnings on the product and in the operating instructions should be adhered to.
- 4 Follow Instructions – All operating and use instructions should be followed.
- 5 Cleaning – Unplug this product from the wall outlet before cleaning. Do not use liquid cleaners or aerosol cleaners.
- 6 Attachments – Do not use attachments not recommended by the product manufacturer as they may cause hazards.
- 7 Water and Moisture – Do not use this product near water – for example, near a bath tub, wash bowl, kitchen sink, or laundry tub; in a wet basement; or near a swimming pool; and the like.
- 8 Accessories – Do not place this product on an unstable cart, stand, tripod, bracket, or table. The product may fall, causing serious injury to a child or adult, and serious damage to the product. Use only with a cart, stand, tripod, bracket, or table recommended by the manufacturer, or sold with the product. Any mounting of the product should follow the manufacturer’s instructions, and should use a mounting accessory recommended by the manufacturer.
- 9 A product and cart combination should be moved with care. Quick stops, excessive force, and uneven surfaces may cause the product and cart combination to overturn.



- 10 Ventilation – Slots and openings in the cabinet are provided for ventilation and to ensure reliable operation of the product and to protect it from overheating, and these openings must not be blocked or covered. The openings should never be blocked by placing the product on a bed, sofa, rug, or other similar surface. This product should not be placed in a built-in installation such as a bookcase or rack unless proper ventilation is provided or the manufacturer’s instructions have been adhered to.
- 11 Power Sources – This product should be operated only from the type of power source indicated on the marking label. If you are not sure of the type of power supply to your home, consult your product dealer or local power company. For products intended to operate from battery power, or other sources, refer to the operating instructions.
- 12 Grounding or Polarization – This product may be equipped with a polarized alternating current line plug (a plug having one blade wider than the other). This plug will fit into the power outlet only one way. This is a safety feature. If you are unable to insert the plug fully into the outlet, try reversing the plug. If the plug should still fail to fit, contact your electrician to replace your obsolete outlet. Do not defeat the safety purpose of the polarized plug.
- 13 Power-Cord Protection – Power-supply cords should be routed so that they are not likely to be walked on or pinched by items placed upon or against them, paying particular attention to cords at plugs, convenience receptacles, and the point where they exit from the product.
- 14 Lightning – For added protection for this product during a lightning storm, or when it is left unattended and unused for long periods of time, unplug it from the wall outlet and disconnect the antenna or cable system. This will prevent damage to the product due to lightning and power-line surges.
- 15 Power Lines – An outside antenna system should not be located in the vicinity of overhead power lines or other electric light or power circuits, or where it can fall into such power lines or circuits. When installing an outside antenna system, extreme care should be taken to keep from touching such power lines or circuits as contact with them might be fatal.
- 16 Overloading – Do not overload wall outlets, extension cords, or integral convenience receptacles as this can result in a risk of fire or electric shock.
- 17 Object and Liquid Entry – Never push objects of any kind into this product through openings as they may touch dangerous voltage points or short-out parts that could result in a fire or electric shock. Never spill liquid of any kind on the product.
- 18 Servicing – Do not attempt to service this product yourself as opening or removing covers may expose you to dangerous voltage or other hazards. Refer all servicing to qualified service personnel.
- 19 Damage Requiring Service – Unplug this product from the wall outlet and refer servicing to qualified service personnel under the following conditions:
 - a) When the power-supply cord or plug is damaged,
 - b) If liquid has been spilled, or objects have fallen into the product,
 - c) If the product has been exposed to rain or water,

- d) If the product does not operate normally by following the operating instructions. Adjust only those controls that are covered by the operating instructions as an improper adjustment of other controls may result in damage and will often require extensive work by a qualified technician to restore the product to its normal operation,
 - e) If the product has been dropped or damaged in any way, and
 - f) When the product exhibits a distinct change in performance - this indicates a need for service.
- 20 Replacement Parts** – When replacement parts are required, be sure the service technician has used replacement parts specified by the manufacturer or have the same characteristics as the original part. Unauthorized substitutions may result in fire, electric shock, or other hazards.
- 21 Safety Check** – Upon completion of any service or repairs to this product, ask the service technician to perform safety checks to determine that the product is in proper operating condition.
- 22 Wall or Ceiling Mounting** – The unit should be mounted to a wall or ceiling only as recommended by the manufacturer.
- 23 Heat** – The product should be situated away from heat sources such as radiators, heat registers, stoves, or other products (including amplifiers) that produce heat.

- 24 Outdoor Antenna Grounding** – If an outside antenna or cable system is connected to the product, be sure the antenna or cable system is grounded so as to provide some protection against voltage surges and built-up static charges. Article 810 of the National Electrical Code, ANSI/NFPA 70, provides information with regard to proper grounding of the mast and supporting structure, grounding of the lead-in wire to an antenna discharge unit, size of grounding conductors, location of antenna discharge unit, connection to grounding electrodes, and requirements for the grounding electrode.

EXAMPLE OF ANTENNA GROUNDING

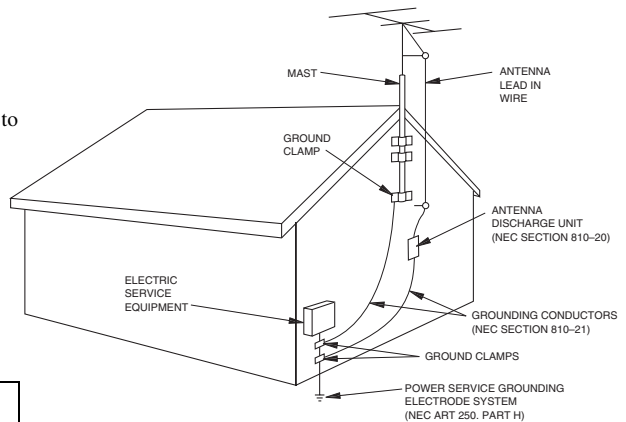

NEC – NATIONAL ELECTRICAL CODE

Note to CATV system installer:

This reminder is provided to call the CATV system installer's attention to Article 820-40 of the NEC that provides guidelines for proper grounding and, in particular, specifies that the cable ground shall be connected to the grounding system of the building, as close to the point of cable entry as practical.

FCC INFORMATION (for US customers)

1 IMPORTANT NOTICE : DO NOT MODIFY THIS UNIT!

This product, when installed as indicated in the instructions contained in this manual, meets FCC requirements. Modifications not expressly approved by Yamaha may void your authority, granted by the FCC, to use the product.

- 2 IMPORTANT :** When connecting this product to accessories and/or another product use only high quality shielded cables. Cable/s supplied with this product **MUST** be used. Follow all installation instructions. Failure to follow instructions could void your FCC authorization to use this product in the USA.

- 3 NOTE :** This product has been tested and found to comply with the requirements listed in FCC Regulations, Part 15 for Class "B" digital devices. Compliance with these requirements provides a reasonable level of assurance that your use of this product in a residential environment will not result in harmful interference with other electronic devices.

This equipment generates/uses radio frequencies and, if not installed and used according to the instructions found in the users manual, may cause interference harmful to the operation of other electronic devices.

Compliance with FCC regulations does not guarantee that interference will not occur in all installations. If this product is found to be the source of interference, which can be determined by turning the unit "OFF" and "ON", please try to eliminate the problem by using one of the following measures:

Relocate either this product or the device that is being affected by the interference.

Utilize power outlets that are on different branch (circuit breaker or fuse) circuits or install AC line filter/s.

In the case of radio or TV interference, relocate/reorient the antenna. If the antenna lead-in is 300 ohm ribbon lead, change the lead-in to coaxial type cable.

If these corrective measures do not produce satisfactory results, please contact the local retailer authorized to distribute this type of product. If you can not locate the appropriate retailer, please contact Yamaha Electronics Corp., U.S.A. 6660 Orangethorpe Ave, Buena Park, CA 90620.

The above statements apply **ONLY** to those products distributed by Yamaha Corporation of America or its subsidiaries.

CAUTION: READ THIS BEFORE OPERATING YOUR UNIT.

- 1 To assure the finest performance, please read this manual carefully. Keep it in a safe place for future reference.
- 2 Install this sound system in a well ventilated, cool, dry, clean place — away from direct sunlight, heat sources, vibration, dust, moisture, and/or cold. Allow ventilation space of at least 5 cm on the top, 5 cm on the left and right, and 10 cm on the back of this unit.
- 3 Locate this unit away from other electrical appliances, motors, or transformers to avoid humming sounds.
- 4 Do not expose this unit to sudden temperature changes from cold to hot, and do not locate this unit in an environment with high humidity (i.e. a room with a humidifier) to prevent condensation inside this unit, which may cause an electrical shock, fire, damage to this unit, and/or personal injury.
- 5 Avoid installing this unit where foreign object may fall onto this unit and/or this unit may be exposed to liquid dripping or splashing. On the top of this unit, do not place:
 - Other components, as they may cause damage and/or discoloration on the surface of this unit.
 - Burning objects (i.e. candles), as they may cause fire, damage to this unit, and/or personal injury.
 - Containers with liquid in them, as they may fall and liquid may cause electrical shock to the user and/or damage to this unit.
- 6 Do not cover this unit with a newspaper, tablecloth, curtain, etc. in order not to obstruct heat radiation. If the temperature inside this unit rises, it may cause fire, damage to this unit, and/or personal injury.
- 7 Do not plug in this unit to a wall outlet until all connections are complete.
- 8 Do not operate this unit upside-down. It may overheat, possibly causing damage.
- 9 Do not use force on switches, knobs and/or cords.
- 10 When disconnecting the power cord from the wall outlet, grasp the plug; do not pull the cord.
- 11 Do not clean this unit with chemical solvents; this might damage the finish. Use a clean, dry cloth.
- 12 Only voltage specified on this unit must be used. Using this unit with a higher voltage than specified is dangerous and may cause fire, damage to this unit, and/or personal injury. YAMAHA will not be held responsible for any damage resulting from use of this unit with a voltage other than specified.
- 13 To prevent damage by lightning, disconnect the power cord from the wall outlet during an electrical storm.
- 14 Do not attempt to modify or fix this unit. Contact qualified YAMAHA service personnel when any service is needed. The cabinet should never be opened for any reasons.
- 15 When not planning to use this unit for long periods of time (i.e. vacation), disconnect the AC power plug from the wall outlet.
- 16 Be sure to read the “TROUBLESHOOTING” section on common operating errors before concluding that this unit is faulty.
- 17 Before moving this unit, press STANDBY/ON to set this unit in the standby mode, and disconnect the AC power plug from the wall outlet.

WARNING

TO REDUCE THE RISK OF FIRE OR ELECTRIC SHOCK, DO NOT EXPOSE THIS UNIT TO RAIN OR MOISTURE.

This unit is not disconnected from the AC power source as long as it is connected to the wall outlet, even if this unit itself is turned off. This state is called the standby mode. In this state, this unit is designed to consume a very small quantity of power.

FOR CANADIAN CUSTOMERS

To prevent electric shock, match wide blade of plug to wide slot and fully insert.
This Class B digital apparatus complies with Canadian ICES-003.

IMPORTANT

Please record the serial number of this unit in the space below.

MODEL:

Serial No.:

The serial number is located on the bottom of the unit. Retain this Owner's Manual in a safe place for future reference.

We Want You Listening For A Lifetime

YAMAHA and the Electronic Industries Association's Consumer Electronics Group want you to get the most out of your equipment by playing it at a safe level. One that lets the sound come through loud and clear without annoying blaring or distortion - and, most importantly, without affecting your sensitive hearing.

Since hearing damage from loud sounds is often undetectable until it is too late, YAMAHA and the Electronic Industries Association's Consumer Electronics Group recommend you to avoid prolonged exposure from excessive volume levels.



CONTENTS

INTRODUCTION

FEATURES	2
GETTING STARTED	3
Supplied accessories	3
Installing batteries in the remote control	3
CONTROLS AND FUNCTIONS	4
Front panel.....	4
Remote control (AMP mode)	5
Using the remote control	6
Front panel display	7

PREPARATION

SPEAKER SETUP	8
Speaker placement	8
Speaker connections	9
CONNECTIONS	11
Before connecting components.....	11
Connecting other components	12
Connecting the antennas.....	14
Connecting the power	15
Turning on the power.....	15
BASIC SETUP	16
Using BASIC setup.....	16

BASIC OPERATION

PLAYBACK	18
Basic operations.....	18
Selecting sound field programs	20
TUNING	22
Automatic and manual tuning.....	22
Presetting stations	24
Selecting preset stations.....	25
RECORDING	27

SOUND FIELD PROGRAMS

SOUND FIELD PROGRAM DESCRIPTIONS	28
For movie/video sources.....	28
For music sources	30

ADVANCED OPERATION

ADVANCED OPERATIONS	31
Using the sleep timer	31
Enjoying multi-channel software.....	31
Enjoying 2-channel software	32
Virtual CINEMA DSP	33
Selecting input modes.....	33
Manually adjusting speaker levels.....	35
Using the test tone	35
SET MENU	36
Changing parameter settings	37
1 SOUND MENU.....	38
2 INPUT MENU	41
3 OPTION MENU	42
REMOTE CONTROL FEATURES	44
Control area	44
Setting remote control codes	45
Controlling other components	46

ADDITIONAL INFORMATION

EDITING SOUND FIELD PARAMETERS	47
What is a sound field	47
Sound field parameter descriptions	47
TROUBLESHOOTING	49
GLOSSARY	53
Audio formats	53
Sound field programs.....	54
Audio information	54
Video signal information	55
SPECIFICATIONS	56

INTRODUCTION

PREPARATION

BASIC OPERATION

SOUND FIELD PROGRAMS

ADVANCED OPERATION

ADDITIONAL INFORMATION

FEATURES

Built-in 5-channel original Yamaha digital power amplifier

- ◆ Minimum RMS output power (0.9% THD, 1 kHz, 6Ω)
Front: 65 W + 65 W
Center: 65 W
Surround: 65 W + 65 W

Sound field features

- ◆ Proprietary YAMAHA technology for the creation of sound fields
- ◆ Dolby Pro Logic/Dolby Pro Logic II decoder
- ◆ Dolby Digital/Dolby Digital + Matrix 6.1 decoder
- ◆ DTS/DTS + Matrix 6.1 decoder
- ◆ DTS 96/24 decoder
- ◆ Virtual CINEMA DSP
- ◆ SILENT CINEMA™

Sophisticated AM/FM tuner

- ◆ 40-station random access preset tuning
- ◆ Automatic preset tuning

Other features

- ◆ 96-kHz/24-bit D/A converter
- ◆ “SET MENU” which provides you with items for optimizing this unit for your audio/video system
- ◆ Screen Menu display output to your TV monitor
- ◆ Slim-line design
- ◆ Optical and coaxial digital audio signal jacks
- ◆ Sleep timer
- ◆ Night listening mode
- ◆ Remote control with preset remote control codes

- ☼ indicates a tip for your operation.
- Some operations can be performed by using either the buttons on the main unit or on the remote control. In cases when the button names differ between the main unit and the remote control, the button name on the remote control is given in parentheses.
- This manual is printed prior to production. Design and specifications are subject to change in part as a result of improvements, etc. In case of differences between the manual and product, the product has priority.



Manufactured under license from Dolby Laboratories.

“Dolby”, “Pro Logic”, and the double-D symbol are trademarks of Dolby Laboratories.



“DTS” and “DTS 96/24” are trademarks of Digital Theater Systems, Inc.

SILENT™
CINEMA

“SILENT CINEMA” is a trademark of YAMAHA CORPORATION.

- The following name plate is located on the bottom of this unit.

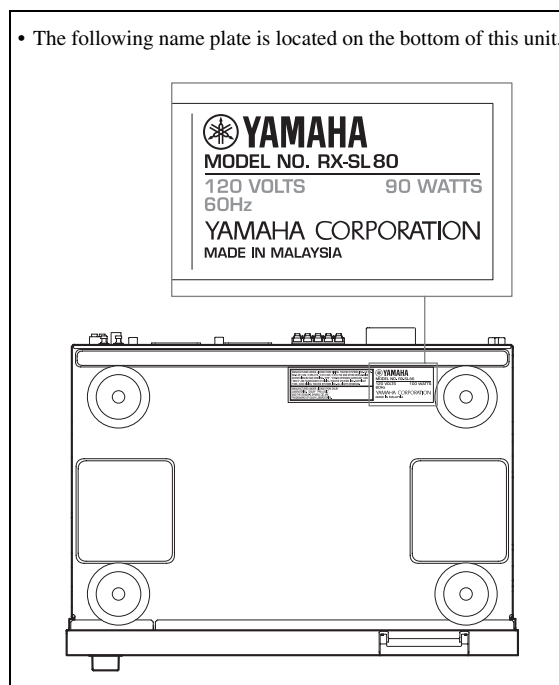

GETTING STARTED

Supplied accessories

Please check that you received all of the following parts.

Remote control

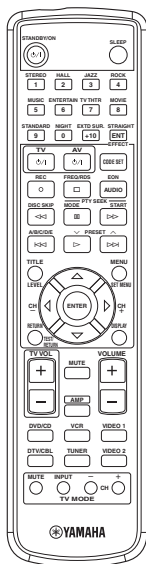

Batteries (2) (AA, R6, UM-3)

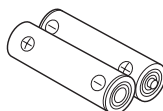

AM loop antenna



Cable tags (5 pairs)



Indoor FM antenna (U.S.A., Canada, China, Asia and General models)

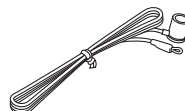

(U.K., Europe, Australia and Korea models)

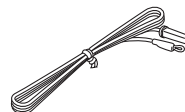

Installing batteries in the remote control

Insert the batteries in the correct direction by aligning the + and - marks on the batteries with the polarity markings (+ and -) inside the battery component.

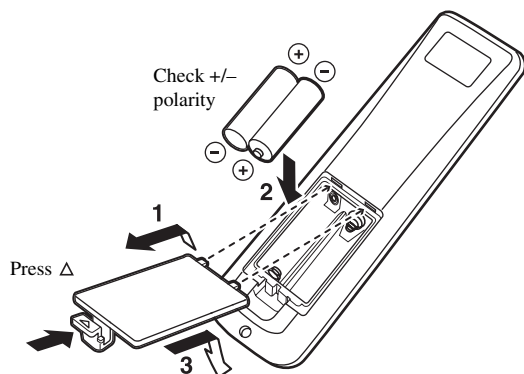

1 Remove the back cover.

2 Insert the two supplied batteries (AA, R6, UM-3) into the battery compartment.

3 Close the back cover.

Notes on batteries

- Change all of the batteries if you notice that the operation range of the remote control has decreased.
- Do not use old batteries together with new ones.
- Do not use different types of batteries (such as alkaline and manganese batteries) together. Read the packaging carefully as these different types of batteries may have the same shape and color.
- If the batteries ran out, immediately remove them from the remote control to prevent an explosion or acid leak.
- Dispose of the batteries according to the regional regulations.
- If the batteries have leaked, dispose of them immediately. Avoid touching the leaked material or letting it come into contact with clothing, etc. Clean the battery compartment thoroughly before installing new batteries.

If the remote control is without batteries for more than 3 minutes, or if exhausted batteries remain in the remote control, the contents of the memory may be cleared. When the memory is cleared, insert new batteries, set up the remote control code and program any acquired functions that may have been cleared.

CONTROLS AND FUNCTIONS

Front panel

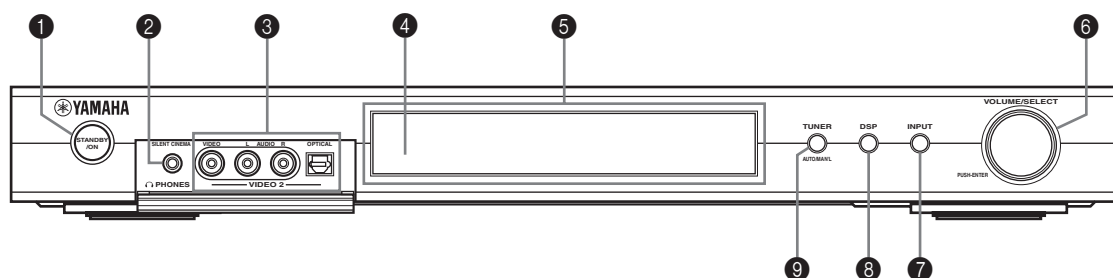

1 STANDBY/ON

Turns on this unit or sets it to the standby mode. When you turn on this unit, you will hear a click and there will be a 4 to 5-second delay before this unit can reproduce sound.

Note

In standby mode, this unit consumes a small amount of power in order to receive infrared-signals from the remote control.

2 PHONES (SILENT CINEMA) jack

Outputs audio signals for headphones. When you connect headphones, no signals are output to the speakers.

All Dolby Digital and DTS audio signals are mixed down to the left and right headphone channels.

3 VIDEO 2 jacks

Input audio and video signals from a portable external source such as a game console. To reproduce source signals from these jacks, select VIDEO 2 as the input source.

4 Remote control sensor

Receives signals from the remote control.

5 Front panel display

Shows information about the operational status of this unit.

6 VOLUME/SELECT

Adjusts the volume and the tone control. Also selects stations, sound field programs or input sources (etc.) when used together with TUNER, DSP, INPUT. If no operation is performed within 5 seconds of pressing TUNER, DSP, INPUT, the VOLUME/SELECT function automatically returns to volume.

7 INPUT

Activates the input select mode.

Activates the AM, FM or preset tuning mode when TUNER is selected as the input source.

8 DSP

Switches between the DSP sound field, STEREO and STRAIGHT modes.

9 TUNER (AUTO/MAN'L)

Activates the tuning mode when TUNER is selected as the input source. Press before turning VOLUME/SELECT to tune in frequencies or preset radio stations.

Switches the AM/FM tuning mode between automatic ("AUTO" indicator on) and manual ("AUTO" indicator off) tuning.

Remote control (AMP mode)

Make sure that the AMP mode is selected before starting operation.

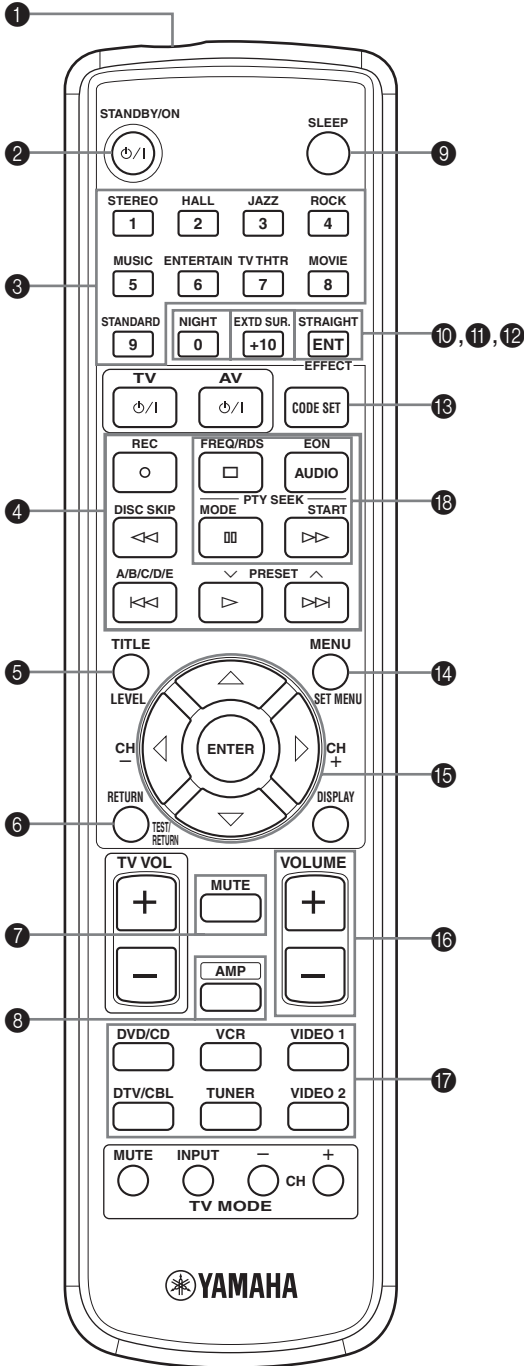

1 Infrared window

Outputs infrared control signals. Aim this window at the component you want to operate.

2 STANDBY/ON

Switches the unit on and sets it in the STANDBY mode.

3 DSP program / Numeric buttons

Use to select sound field programs or input numbers according to the current control area.

4 Operation buttons

Provide functions such as play, stop, skip, etc. for use when operating other components.

5 LEVEL

Selects the speaker channel to be adjusted and sets the level.

6 TEST/RETURN

Outputs the test tone to adjust the speaker levels. Returns to the previous menu level when adjusting the SET MENU parameters.

7 MUTE

Mutes the sound. Press again to restore the audio output to the previous volume level.

8 AMP

Sets the remote control to the AMP mode for controlling this unit (instead of the component selected using the input selector buttons).

9 SLEEP

Sets the sleep timer.

10 NIGHT

Turns night listening mode on or off.

11 EXT D SUR.

Switches on or off the Dolby Digital + Matrix 6.1 or DTS + Matrix 6.1 decoding mode.

12 STRAIGHT/EFFECT

Switches the sound fields off or on. When STRAIGHT is selected, input signals (2-channel or multi-channel) are output directly from their respective speakers without effect processing.

13 CODE SET

Used to set up remote control codes.

14 SET MENU

Turns the SET MENU on or off.

15 Multi control section

Use to select and adjust DSP program parameters or SET MENU items.

16 VOLUME +/-

Increases or decreases the volume level.

17 Input selector buttons

Use to select the input source and change the control area.

■ U.K. and Europe models only

18 RDS tuning buttons

FREQ/RDS

Press this button when the unit is receiving an RDS station to cycle the display between the PS mode, PTY mode, RT mode, CT mode (if the station offers those RDS data service) and/or the frequency display.

PTY SEEK MODE

Press this button to set the unit to the PTY SEEK mode.

PTY SEEK START

Press this button to begin searching for a station after the desired program type has been selected in the PTY SEEK mode.

EON

Press this button to select a radio program type (NEWS, INFO, AFFAIRS, SPORT) to tune in automatically.

Using the remote control

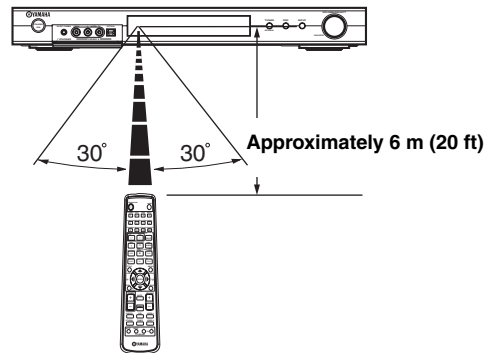

The remote control transmits a directional infrared beam. Be sure to aim the remote control directly at the remote control sensor on the main unit during operation.

■ Handling the remote control

- Do not spill water or other liquids on the remote control.
- Do not drop the remote control.
- Do not leave or store the remote control in the following types of conditions:
 - high humidity such as near a bath
 - high temperature such as near a heater or stove
 - extremely low temperature
 - dusty places

Front panel display

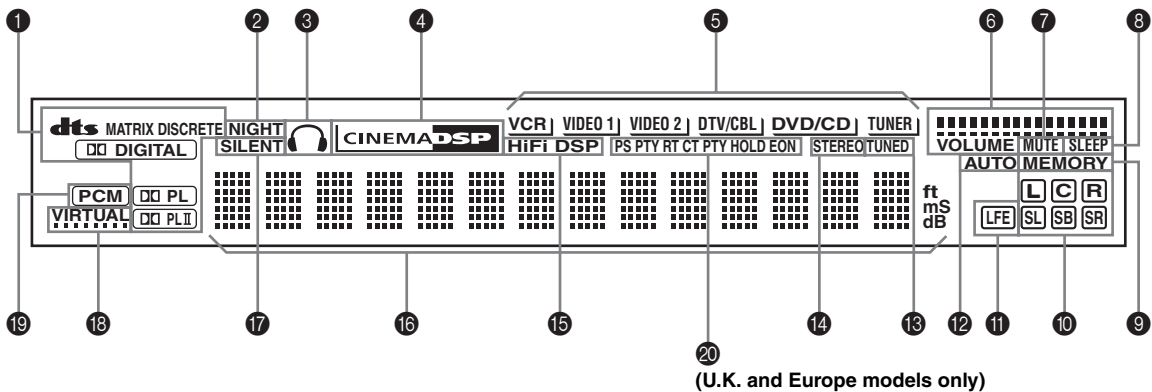

1 Processor indicators

When any of this unit's decoders function, the respective indicator lights up.

2 NIGHT indicator

Lights up when you select NIGHT LISTENING mode.

3 Headphones indicator

Lights up when headphones are connected.

4 CINEMA DSP indicator

Lights up when you select a CINEMA DSP sound field program.

5 Input source indicators

A cursor lights to show the current input source.

6 VOLUME level indicators

Indicate the volume level.

7 MUTE indicator

Flashes while the MUTE function is on.

8 SLEEP indicator

Lights up while the sleep timer is on.

9 MEMORY indicator

Flashes to show a station can be stored in memory.

10 Input channel indicators

Indicates the channel components of the input digital signal.

11 LFE indicator

Lights up when the input signal contains the LFE signal.

12 AUTO indicator

Shows that this unit is in the automatic tuning mode.

13 TUNED indicator

Lights up when this unit is tuned into a station.

14 STEREO indicator

Lights up when this unit is receiving a strong signal for an FM stereo broadcast while the "AUTO" indicator is lit.

15 HiFi DSP indicator

Lights up when you select a HiFi DSP sound field program.

16 Multi-information display

Shows the current sound field program name and other information when adjusting or changing settings.

17 SILENT CINEMA indicator

Lights up when headphones are connected and a sound field program is selected (see page 19).

18 VIRTUAL indicator

Lights up when Virtual CINEMA DSP is active (see page 33).

19 PCM indicator

Lights up when this unit is reproducing PCM (pulse code modulation) digital audio signals.

20 RDS indicators

(U.K. and Europe models only)

The name(s) of the RDS data offered by the currently received RDS station light(s) up.

EON lights up when an RDS station that offers the EON data service is being received.

PTY HOLD lights up while searching for stations in the PTY SEEK mode.

SPEAKER SETUP

Speaker placement

You can enjoy this unit with the following speaker setup to obtain the best surround sound.

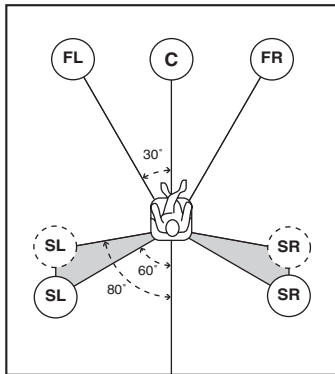

The speaker layout above shows the standard ITU-R* speaker setting. ITU-R recommends that the front left and right speakers be placed at 30° from the central listening position, and that the surround left and right speakers be placed at between 60° and 80° from the central listening position.

* ITU-R: for more information (see page 54).

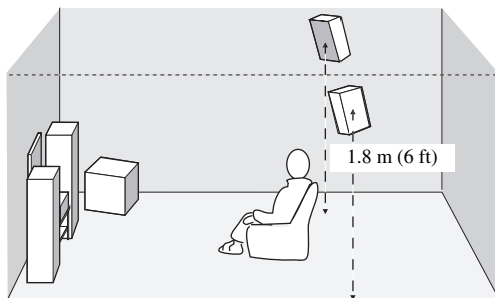

Front speakers (FR and FL)

The front speakers are used for the main source sound plus effect sounds. Place these speakers an equal distance from the ideal listening position. The distance of each speaker from each side of the video monitor should be the same.

Center speaker (C)

The center speaker is for the center channel sounds (dialog, vocals, etc.). If for some reason it is not practical to use a center speaker, you can do without it. Best results, however, are obtained with the full system. Align the front face of the center speaker with the front face of your video monitor. Place the speaker centrally between the front speakers and as close to the monitor as possible, such as directly over or under it.

Surround speakers (SR and SL)

The surround speakers are used for effect and surround sounds. Place these speakers behind your listening position, facing slightly inwards, about 1.8 m (6 ft) above the floor.

Subwoofer

The use of a subwoofer, such as the YAMAHA Active Servo Processing Subwoofer System, is effective not only for reinforcing bass frequencies from any or all channels, but also for high fidelity reproduction of the LFE (low-frequency effect) channel included in Dolby Digital and DTS software. The position of the subwoofer is not so critical, because low bass sounds are not highly directional. But it is better to place the subwoofer near the front speakers. Turn it slightly toward the center of the room to reduce wall reflections.

Speaker connections

Be sure to connect the left channel (L), right channel (R), “+” (colored) and “-” (black) properly. If the connections are faulty, no sound will be heard from the speakers, and if the polarity of the speaker connections is incorrect, the sound will be unnatural and lack bass.

CAUTION

- Before connecting the speakers, make sure that the power of this unit is off.
- Do not let the bare speaker wires touch each other or do not let them touch any metal part of this unit. This could damage this unit and/or speakers.
- Use magnetically shielded speakers. If this type of speakers still creates the interference with the monitor, place the speakers away from the monitor.

A speaker cord is actually a pair of insulated cables running side by side. One cable is colored or shaped differently, perhaps with a stripe, groove or ridges. Connect the striped (grooved, etc.) cable to the “+” (colored) terminals on this unit and your speaker. Connect the plain cable to the “-” (black) terminals.

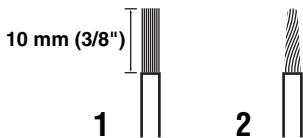

- 1 Remove approximately 10 mm (3/8") of insulation from each of the speaker cables.**
- 2 Twist the exposed wires of the cable together to prevent short circuits.**
- 3 Press and hold the tab to insert the speaker wire.**

- 4 Return the tab to secure the wire.**

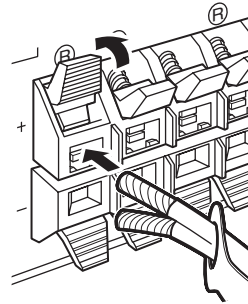

Colored: positive (+)
Black: negative (-)

■ Cable tags

5 pairs of different colored cable tags are provided with this product. The colors of the cable tags and their respective speaker cables are as follows:

- Red: Front right speaker cable
- White: Front left speaker cable
- Green: Center speaker cable
- Gray: Surround right speaker cable
- Blue: Surround left speaker cable

To make it easier to distinguish the various speaker cables, attach the colored tags to the appropriate speaker cables as shown below.

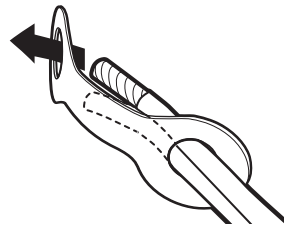

■ **Speaker connections**

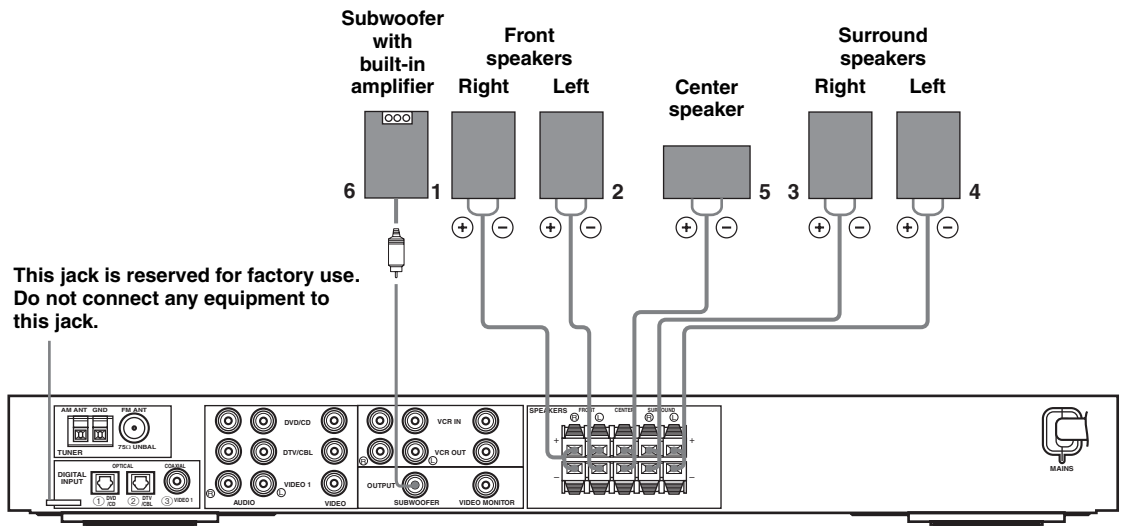

■ **FRONT terminals**

Connect your speaker system to these terminals.

■ **SURROUND terminals**

Connect surround speakers to these terminals.

■ **CENTER terminals**

Connect a center speaker to these terminals.

■ **SUBWOOFER OUTPUT jack**

Connect a subwoofer with built-in amplifier, such as the YAMAHA Active Servo Processing Subwoofer System, to this jack.



You can easily distinguish between the cable pairs by attaching a supplied cable tag to each end of the respective speaker cable (see page 9).

Notes

- If you are not using a subwoofer, allocate the signals to the front left and right speakers by changing the setting item “LFE/Bass Out” to FRONT on the SOUND menu (see page 39).
- Use the control on the subwoofer to adjust its volume level. You can also adjust the volume level using this unit’s remote control (see page 35).

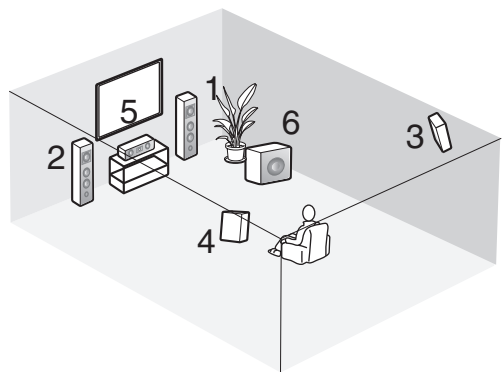

Speaker layout

CONNECTIONS

Before connecting components

CAUTION

Do not connect this unit or other components to the mains power until all connections between components are complete.

- Make sure that all connections are made correctly - that is to say, L (left) to L, R (right) to R, “+” to “+” and “-” to “-”. Some components require different connection methods and have different jack names. Refer to the operating instructions for each component you wish to connect to this unit.
- After you have completed all connections, check them again to make sure they are correct.
- The jack names correspond to the names on the input selector.

Signal directions and cable indications

audio signal direction 

video signal direction 

For analog signals

left analog cables 

right analog cables 

For digital signals

optical cables 

coaxial cables 

For video signals

video cables 

Analog jacks

You can input analog signals from audio components by connecting audio pin cable to the analog jacks on this unit. Connect red plugs to the right jacks and white plugs to the left jacks.

Digital jacks

This unit has digital jacks for direct transmission of digital signals through either coaxial or fiber optic cables. You can use the digital jacks to input PCM, Dolby Digital and DTS bitstreams. All digital input jacks are compatible with 96-kHz sampling digital signals.

Notes

- This unit handles digital and analog signals independently. Thus audio signals input to the digital (OPTICAL or COAXIAL) jacks are not output to the analog VCR OUT (REC) jacks.
- The OPTICAL jacks on this unit conform to the EIA standard. If you use a fiber optic cable that does not conform to this standard, this unit may not function properly.

Dust protection cap

Pull out the cap from the optical jack before you connect the fiber optic cable. Do not discard the cap. When you are not using the optical jack, be sure to put the cap back in place. This cap protects the jack from dust.

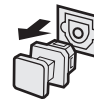

Connecting other components

■ Connections for DVD playback

Connect your DVD player and video monitor to the jacks on the rear panel of this unit.

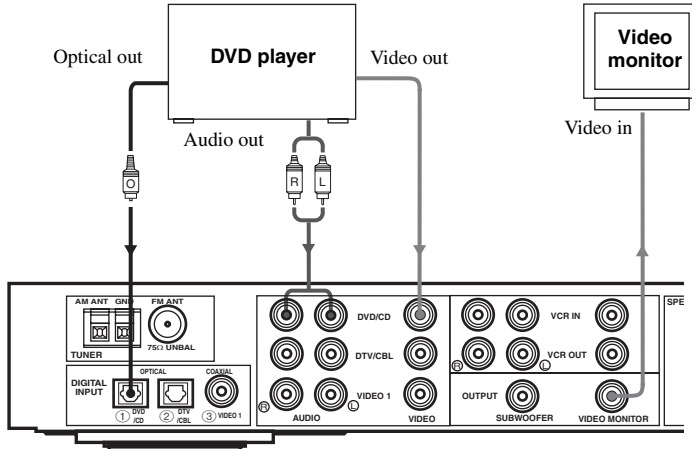

Note

You may experience some image distortion if your DVD player is connected to this unit through your VCR rather than being directly connected to this unit.

■ Connections for other AV components

Connect the desired component(s) to the jacks on the rear panel of this unit.

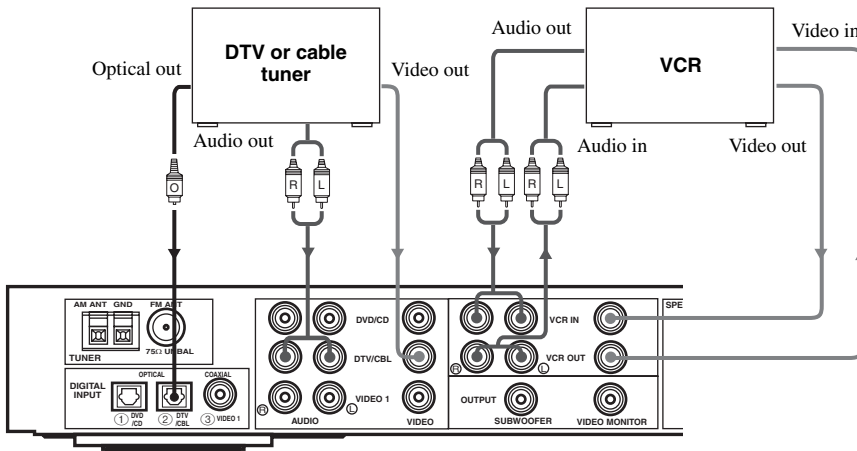

You can assign how this unit's DIGITAL INPUT jacks correspond to the component to be used if this unit's initial settings do not meet your needs (see page 41).

■ VIDEO 2 jacks (on the front panel)

Use these jacks to connect any video source, such as a game console or video camera, to this unit.

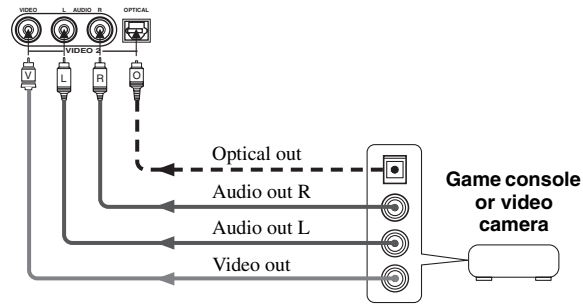

Connecting the antennas

Both AM and FM indoor antennas are included with this unit. In general, these antennas should provide sufficient signal strength. Connect each antenna correctly to the designated terminals.

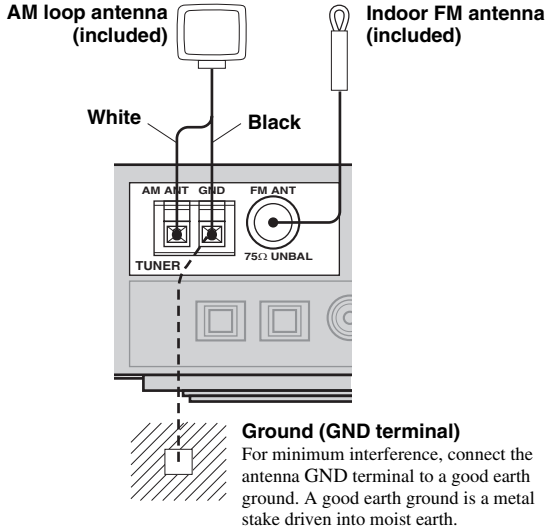

■ Connecting the AM loop antenna

1 Set up the AM loop antenna, then connect it to the terminals on this unit.

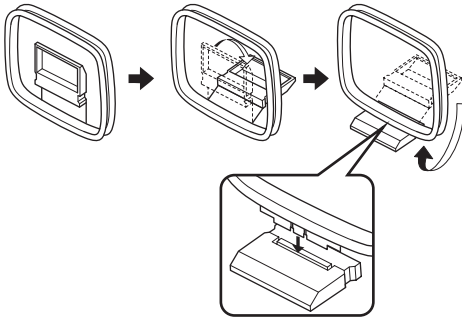

2 Lift up the tab and insert the white cord into the AM ANT terminal and the black cord into the GND terminal.

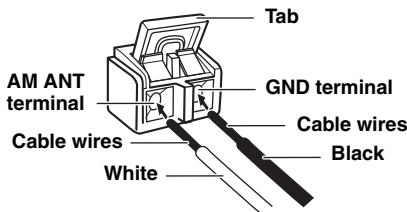

3 Orient the AM loop antenna for the best reception.



Notes

- The AM loop antenna should be placed away from this unit and all speaker cords.
- The AM loop antenna should always be connected, even if an outdoor AM antenna is connected to this unit.
- A properly installed outdoor antenna provides clearer reception than an indoor one. If you experience poor reception quality, an outdoor antenna may improve the quality. Consult the nearest authorized YAMAHA dealer or service center about outdoor antennas.

■ Frequency Step (Asia and General models only)

Because the interstation frequency spacing differs in different areas, set the FREQUENCY STEP (using SET MENU) according to the frequency spacing in your area (see page 43).

- North, Central and South America: 100 kHz/10 kHz
- Other areas: 50 kHz/9 kHz

Connecting the power

■ Connecting the AC power

After all other connections are complete, plug the power cord to an AC wall outlet.

■ Memory back-up

The memory back-up circuit prevents the stored data from being lost even if this unit is in the standby mode. However if the power cord is disconnected from the AC wall outlet, or the power supply is cut for more than one week, the stored data will be lost.

Turning on the power

When all connections are complete, turn on the power of this unit.



or

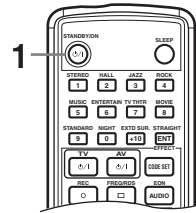

- 1 Press **STANDBY/ON** on the front panel or remote control to turn on the power of this unit.



Front panel

or



Remote control

The level of the main volume, and then the current sound field program name appear in the front panel display.

- 2 Turn on the video monitor connected to this unit.

BASIC SETUP

The BASIC setup feature is a useful way to set up your system quickly and with minimal effort. The BASIC setup items are displayed on both the front panel of this unit and your video monitor. By using the Screen Menu on your video monitor, you can easily make any necessary settings.



- If you wish to configure the unit manually using more precise adjustments, use the detailed parameters in SOUND MENU (page 38) instead of using BASIC SETUP.
- Altering the parameters in BASIC SETUP may cause some of the parameters in SOUND MENU to be overwritten.
- The explanations in this document are based on the Screen Menu. The characters shown in the front panel display may differ from those on the Screen Menu.

Using BASIC SETUP

■ Speaker set up

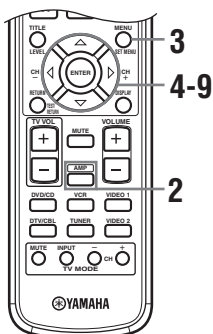

1 Switch on the receiver and video monitor.

2 Press AMP.



3 Press SET MENU.

The top display appears on your video monitor.



4 Press ▲/▼ to select BASIC SETUP, then press ENTER.

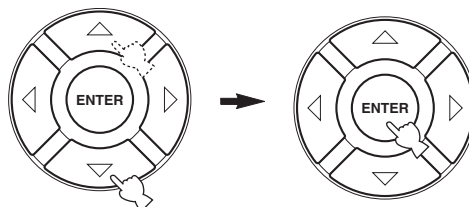

5 Press ▲/▼ repeatedly to select ROOM.

Use ◀/▶ to select the size of the room you have installed your speakers in. Roughly speaking, the room sizes are defined as follows:



[U.S.A. and Canada models]

S (small)	16 x 13 ft, 200 sq. ft (4.8 x 4.0 m, 20 m ²)
M (medium)	20 x 16 ft, 300 sq. ft (6.3 x 5.0 m, 30 m ²)
L (large)	26 x 19 ft, 450 sq. ft (7.9 x 5.8 m, 45 m ²)

[Other models]

S (small)	3.6 x 2.8 m, 10 m ²
M (medium)	4.8 x 4.0 m, 20 m ²
L (large)	6.3 x 5.0 m, 30 m ²

6 Press Δ / ∇ repeatedly to select SWFR.

Use \leftarrow / \rightarrow to select YES or NONE.

- YES If you have a subwoofer in your system.
- NONE If you do not have a subwoofer in your system.

7 Press Δ / ∇ repeatedly to select SPEAKERS.

Use \leftarrow / \rightarrow to select the number of speakers connected to the unit. The choices vary as follows:

Choices	Display	Speakers
2 spk		Front L/R
3 spk		Front L/R, Center
4 spk		Front L/R, Surround L/R
5 spk		Front L/R, Center, Surround L/R

8 After you have finished the settings, press ∇ repeatedly to select SET CANCEL.

Use \leftarrow / \rightarrow to select SET or CANCEL, then press ENTER.

- SET To apply the changes and start the test tone.
- CANCEL To cancel the changes and return to SET MENU.

Use the test tone to check the speaker levels. If you selected SET, the display changes to:



and the unit outputs a test tone from each speaker in turn.

When the test tone begins, the display changes to:



Notes

- The unit cycles the test tone around each of the speakers in turn twice.
- The indicator of the speaker currently outputting the test tone flashes in the front panel display.

9 Press \leftarrow / \rightarrow repeatedly to select YES or NO, then press ENTER.

If you want to change the speaker level after you hear the test tone select “NO”.

- YES To return to SET MENU.
- NO To enter B)SPEAKER LEVEL.

Speaker level B)SPEAKER LEVEL

Use this menu to compare and adjust the test tone output from each speaker to the output from the left front (or left surround) speaker so that the volume level for all speakers is identical.

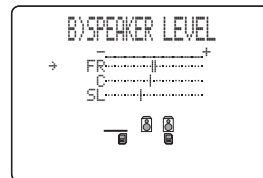

Press Δ / ∇ to select a speaker and adjust the balance using \leftarrow / \rightarrow .

The unit outputs the test tone from the selected speaker and the left front (or left surround) speaker in turn. The indicator of the speaker currently outputting the test tone flashes in the front panel display.

FR adjusts the balance between the front left and right speakers.

C adjusts the balance between the front left and center speakers.

SL adjusts the balance between the front left and surround left speakers.

SR adjusts the balance between the surround left and surround right speakers.

SWFR adjusts the balance between the front left speaker and the subwoofer.



You can also make test tone setting adjustments by pressing TEST on the remote control.

Memory back-up

The memory back-up circuit prevents the stored data from being lost even if this unit is in the standby mode. However, if the power cord is disconnected from the AC outlet, or the power supply is cut for more than one week, the stored data will be lost. If so, adjust the items again.

PLAYBACK

Basic operations



or

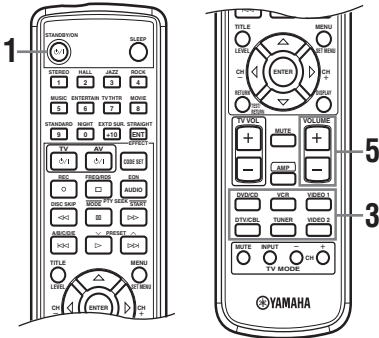

- Press **INPUT**, then rotate **VOLUME/SELECT** within 5 seconds to select the input source (or press an input selector button on the remote control).

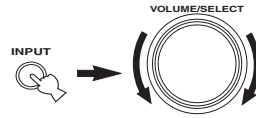

Front panel

or

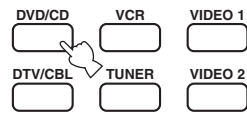

Remote control

The current input source name and input mode appear in the front panel display for a few seconds.



Selected input source

Input mode

- Press **STANDBY/ON** to turn on the power.



Front panel

or



Remote control

- Turn on the video monitor connected to this unit.

Note

If no operation is performed within 5 seconds of pressing **INPUT** or **VOLUME/SELECT** is pressed on the front panel, the function of **VOLUME/SELECT** switches back to volume level adjustment. If this happens, "VOLUME" appears in the front panel display for a few seconds.

- Start playback or select a broadcast station on the source component.

Refer to the operation instructions for the component.

- Adjust the volume to the desired output level.



Front panel

or



Remote control

To listen with headphones (SILENT CINEMA)

The SILENT CINEMA mode allows you to enjoy multi-channel music or movie sound, including Dolby Digital and DTS surround, through ordinary headphones. SILENT CINEMA activates automatically whenever you connect headphones to the PHONES jack while listening to DSP sound field programs. The SILENT CINEMA indicator lights up in the front panel display. “SILENT CINEMA” is not effective when the Direct Stereo or 2ch Stereo program is selected, or in STRAIGHT mode.

To adjust the tone

You can adjust the tonal quality of your front left and right speakers or headphones (when connected).

Press VOLUME/SELECT on the front panel repeatedly to select TREBLE or BASS, then rotate to the right or left to increase or decrease.

- Select TREBLE to adjust the high frequency response.
- Select BASS to adjust the low frequency response.

To cancel the tone control setting, press VOLUME/SELECT again, or press VOLUME +/- on the remote control or operate nothing for 5 seconds.



Speaker and headphone adjustments are stored independently.

Notes

- If you increase or decrease the high-frequency or low-frequency sound to an extreme level, the tonal quality of the surround speakers may not match that of the front left and right speakers.
- TONE CONTROL is not effective with the Direct Stereo program (page 32).

To mute the sound

Press MUTE on the remote control. “MUTE” blinks in the front panel display.

To resume the audio output, press MUTE again (or press VOLUME +/-). “MUTE” disappears from the display.



You can adjust the muting level (see page 41).

■ Playing video sources in the background

You can combine a video image from a video source with sound from an audio source. For example, you can enjoy listening to classical music while viewing beautiful scenery from the video source on the video monitor.

Use the input selector buttons on the remote control to select a video source, then select an audio source.

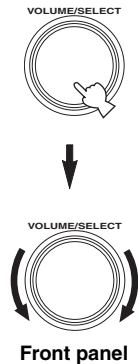
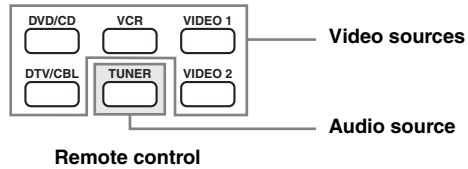

Front panel



Remote control

Selecting sound field programs

Remote control operation

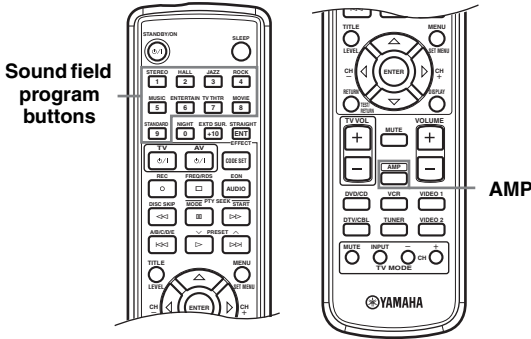

Press AMP to select the AMP mode, then press one of the sound field program buttons repeatedly to select the desired program.

The name of the selected program appears in the front panel display.

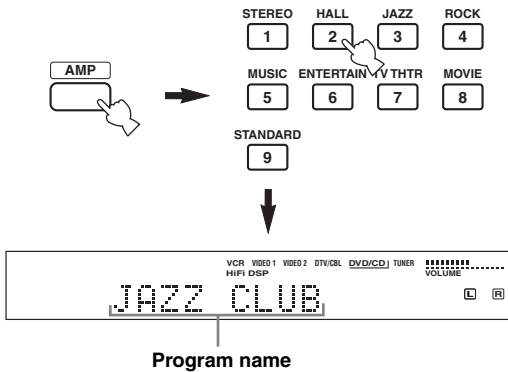

Front panel operation

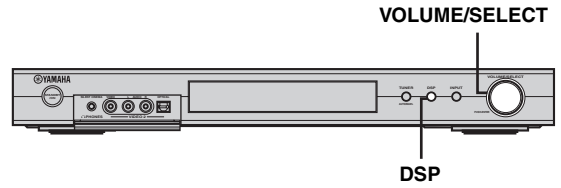

Press DSP, then rotate VOLUME/SELECT within 5 seconds.

The name of the selected program appears in the front panel display.

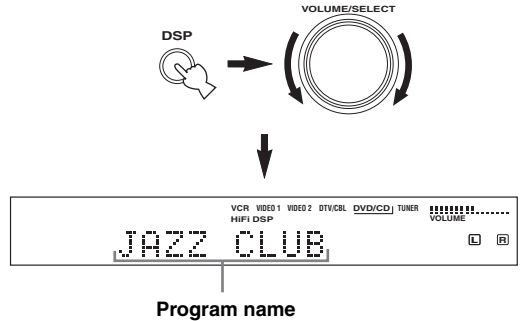

Choose a sound field program based on your listening preference, and not on the name of the program.

Notes

- If no operation is performed within 5 seconds of pressing DSP on the front panel, the function of VOLUME/SELECT switches back to volume.
- After selecting a DSP program, press VOLUME/SELECT to switch the function of VOLUME/SELECT back to "volume".
- There are 9 programs with sub-programs available with this unit. However, the selection depends on the input signal format and not all sub-programs can be used with all input signal formats.
- The acoustics of your listening room affect the sound field program. Minimize the sound reflections in your room to maximize the effect created by the program.
- When you select an input source, this unit automatically selects the last sound field program used with that source.
- When you set this unit in standby mode, it stores the current source and sound field program in memory and automatically selects them when you turn on the power again.
- If the unit receives a Dolby Digital or DTS signal when the input mode is set to AUTO, the CINEMA DSP sound field programs automatically switches to the appropriate decoding program.
- When the unit is reproducing a monaural source with PRO LOGIC, PRO LOGIC Enhanced, PRO LOGIC II Game or PRO LOGIC II Movie, no sound is output from the front and surround speakers. Sound can only be heard from the center speaker. (If CENTER SP in SPEAKER SET in the SOUND menu is set to "None", the center channel sound is output from the front speakers.)
- Sampling frequencies higher than 48 kHz (except for DTS 96/24 signals) will be sampled down to 48 kHz, then sound field programs will be applied.

■ Night listening modes

The night listening modes are designed to improve listenability at lower volumes or at night. Choose either NIGHT:CINEMA or NIGHT:MUSIC depending on the type of material you are playing.

Press NIGHT on the remote control repeatedly to select cinema or music.

When night listening is selected, the NIGHT indicator in the front panel display lights up.



Remote control

- Select NIGHT:CINEMA when watching films to reduce the dynamic range of film soundtracks and make dialog easier to hear at lower volumes.
- Select NIGHT:MUSIC when listening to music sources to preserve ease-of-listening for all sounds.
- Select OFF if you do not want to use this function.

Press </> to adjust the effect level while NIGHT:CINEMA or NIGHT:MUSIC is displayed.

This adjusts the level of compression.

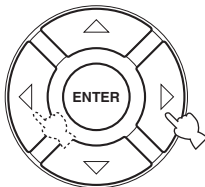

Remote control

Effect..Lv1:MID

- Select MIN for minimum compression.
- Select MID for standard compression.
- Select MAX for maximum compression.



NIGHT:CINEMA and NIGHT:MUSIC adjustments are stored independently.

Notes

- You cannot use the night listening modes with the Direct Stereo program (even though the NIGHT indicator lights up when Direct Stereo is selected).
- The night listening modes may vary in effectiveness depending on the input source and surround sound settings you use.

■ Downmixing to 2 channels

You can enjoy 2-channel stereo playback even from multi-channel sources.

Press DSP, then rotate VOLUME/SELECT (or press STEREO on the remote control) to select 2ch Stereo.

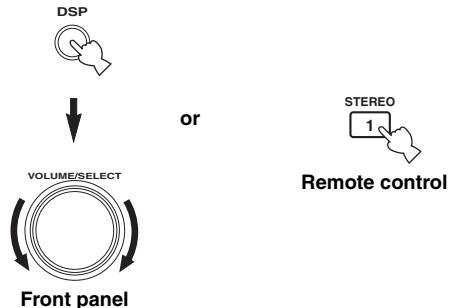

2ch Stereo



- You can use a subwoofer with this program when SWFR or BOTH is selected in “BASS OUT”.
- You can enjoy pure high fidelity sound from 2-channel sources when “Direct Stereo” is selected (see page 32).

■ Listening to unprocessed input signals

In STRAIGHT mode, two channel stereo sources are output from only the front left and right speakers. Multi-channel sources are decoded straight into the appropriate channels without any additional effect processing.

Press STRAIGHT/EFFECT to select STRAIGHT.



Remote control

STRAIGHT

Press STRAIGHT/EFFECT again so that “STRAIGHT” disappears from the display when you want to turn the sound effect back on.

TUNING

Automatic and manual tuning

There are 2 tuning methods; automatic and manual. Automatic tuning is effective when station signals are strong and there is no interference.

Automatic tuning

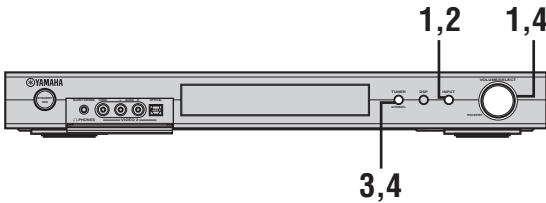

- 1 Press **INPUT**, then rotate **VOLUME/SELECT** within 5 seconds to select **TUNER**.

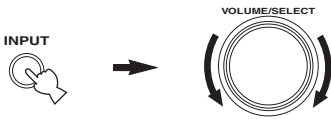

Note

If no operation is performed within 5 seconds of pressing **INPUT** or **VOLUME/SELECT** is pressed on the front panel, the function of **VOLUME/SELECT** switches back to volume level adjustment. If this happens, “**VOLUME**” appears in the front panel display for a few seconds.

- 2 Press **INPUT** repeatedly on the front panel to select the reception band you want to tune. “**FM**” or “**AM**” and the current frequency appear in the front panel display.

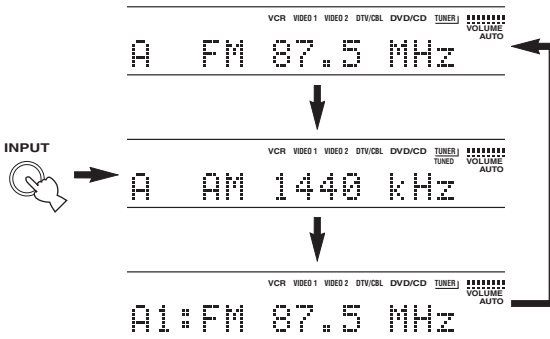

- 3 Hold down **TUNER (AUTO/MAN'L)** for more than 1 second so that the “**AUTO**” indicator lights up in the front panel display.

If “**AUTO**” is already lit up in the front panel display, you do not need to perform this step. In this case, skip to step 4.



- 4 Press **TUNER (AUTO/MAN'L)**, then rotate **VOLUME/SELECT** within 5 seconds to begin automatic tuning.

Rotate rightward to tune to a higher frequency, or rotate leftward to tune to a lower frequency.



Note

When tuned into a station, the “**TUNED**” indicator lights up and the frequency of the received station is shown in the front panel display.

Manual tuning

If the signal from the station you want to select is weak, you must tune into it manually.

1 Press INPUT, then rotate VOLUME/SELECT within 5 seconds to select TUNER.

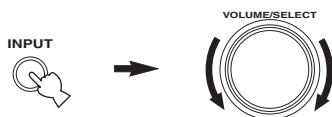

Note

If no operation is performed within 5 seconds of pressing INPUT or VOLUME/SELECT is pressed on the front panel, the function of VOLUME/SELECT switches back to volume level adjustment. If this happens, "VOLUME" appears in the front panel display for a few seconds.

2 Press INPUT repeatedly on the front panel to select the reception band you want to tune.

"FM" or "AM" and the current frequency appear in the front panel display.

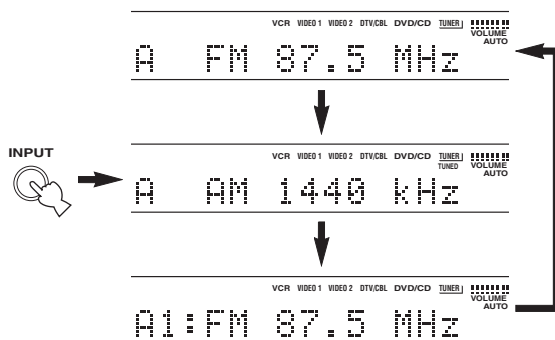

3 Hold down TUNER (AUTO/MAN'L) for more than 1 second until the "AUTO" indicator disappears from the front panel display.

If "AUTO" is not shown in the front panel display, you do not need to perform this step. In this case, skip to step 4.



Disappears

4 Press TUNER (AUTO/MAN'L), then rotate VOLUME/SELECT within 5 seconds to tune into the desired station manually.

Rotate rightward to tune to a higher frequency, or rotate leftward to tune to a lower frequency.

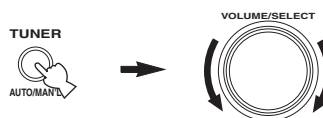

Notes

- Manually tuning to FM stations will automatically change the reception mode to monaural to increase the signal sensitivity.
- When tuned into a station, the "TUNED" indicator lights up and the frequency of the received station is shown in the front panel display.

Presetting stations

■ Automatically presetting FM stations

You can use the automatic preset tuning feature to store FM stations. This function enables this unit to automatically tune in to FM stations with strong signals, and to store up to 40 (8 stations x 5 groups) of those stations in order. You can then recall any preset station easily by selecting the preset station number.

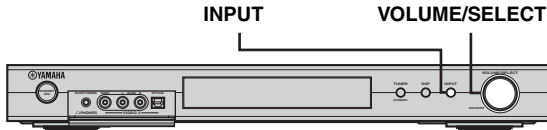

1 Press INPUT, then rotate VOLUME/SELECT within 5 seconds to select TUNER.

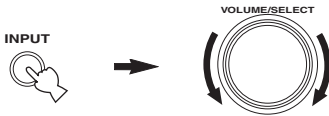

Note

If no operation is performed within 5 seconds of pressing INPUT or VOLUME/SELECT is pressed on the front panel, the function of VOLUME/SELECT switches back to volume level adjustment. If this happens, "VOLUME" appears in the front panel display for a few seconds.

2 Press INPUT repeatedly on the front panel to select the FM band you want to preset.

"FM" appears in the front panel display.



3 Hold down VOLUME/SELECT for more than 5 seconds.

The "AUTO" and "MEMORY" indicators flash in the display and after about 5 seconds, automatic presetting starts from the lowest frequency, proceeding to higher frequencies.



When automatic preset tuning is completed, the front panel display shows the frequency of the last preset station.

Notes

- Any stored station data existing under a preset number is cleared when you store a new station under that preset number.
- If the number of the received stations does not reach E8, automatic preset tuning automatically stops after searching all stations.
- Only FM stations with sufficient signal strength are stored automatically by automatic preset tuning. If the station you want to store is weak in signal strength, tune in to it manually in the monaural mode, and store it by following the procedure in "Manually presetting stations".

Memory back-up

The memory back-up circuit prevents the stored data from being lost even if this unit is set in the standby mode, the power cord is disconnected from the AC outlet, or the power supply is temporarily cut due to power failure. However, if the power is cut for more than one week, the preset stations may be cleared. If so, store the stations again by using the presetting station methods.

Manually presetting stations

You can also store up to 40 stations (8 stations x 5 groups) manually.

1 Tune into a station.

See page 22 for tuning instructions.

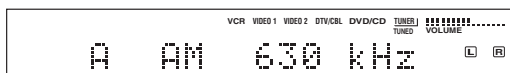

When tuned into a station, the front panel display shows the frequency of the station received.

2 Hold down VOLUME/SELECT for approximately 3 seconds to activate the manual preset station mode.

The colon (:) blinks and the “MEMORY” indicator flashes in the display.



Rotate VOLUME/SELECT to select a preset station number (A1 to E8) while “MEMORY” is flashing. Rotate rightward to select a higher preset station number, or rotate leftward to select a lower preset station number.

Note

When presetting an FM station, pressing VOLUME/SELECT for an extended period activates the automatic preset tuning feature (see page 24).

3 Press VOLUME/SELECT to set the selected preset station number.

The station band and frequency appear in the front panel display with the preset group and number you have selected.



Repeat steps 1 to 3 to store other stations.

Notes

- Any stored station data existing under a preset number is cleared when you store a new station under that preset number.
- The reception mode (stereo or monaural) is stored along with the station frequency.

Selecting preset stations

You can tune into any desired station simply by selecting the preset station number under which it was stored.

Remote control operation

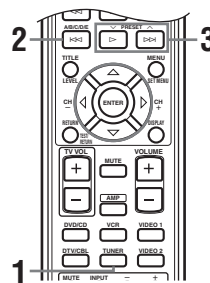

1 Press TUNER to select TUNER.

2 Press A/B/C/D/E to select the preset station group.

The preset group letter appears in the front panel display and changes each time you press the button.

3 Press ^ PRESET v (or use the numeric buttons) to select a preset station number.

The preset group and number appear in the front panel display along with the station band, frequency and the “TUNED” indicator lights up.

■ Front panel operation

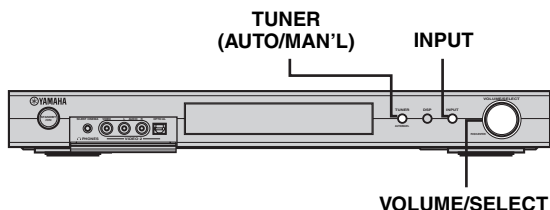

- 1 Press **INPUT**, then rotate **VOLUME/SELECT** within 5 seconds to select **TUNER**.

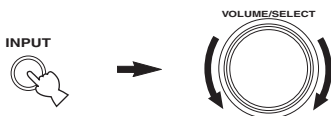

- 2 Press **INPUT** repeatedly to select preset tuning mode.

A colon (:) appears in the front panel display in front of the station band and frequency.



- 3 Press **TUNER (AUTO/MAN'L)**.

The "TUNER" indicator flashes for about 5 seconds, and **VOLUME/SELECT** shifts to the preset number selection mode.

- 4 Rotate **VOLUME/SELECT** to select a preset station while the "TUNER" indicator is flashing.

RECORDING

Recording adjustments and other operations are performed from the recording components. For details, refer to the operation instructions for those components.

Before you begin, make sure you have connected all components properly.

Notes

- It is not possible to record signals input through the DIGITAL INPUT jacks.
- Do a test recording before you start an actual recording.
- The volume, speaker level, and sound field program settings do not affect the recorded material.

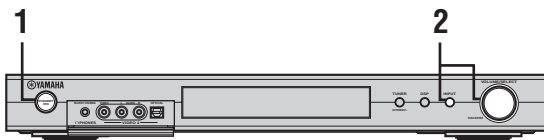

or

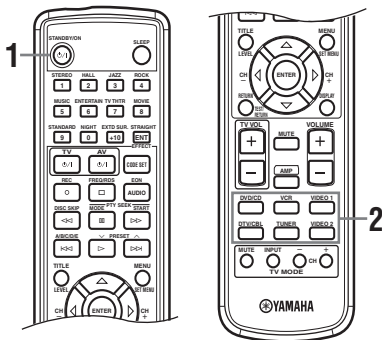

- 1 Turn on the power of this unit and all connected components.**
- 2 Press INPUT, then rotate VOLUME/SELECT within 5 seconds (or press an input selector button on the remote control) to select the source component (input source) you want to record from, such as “VIDEO 1”, “DTV/CBL”, or “DVD/CD” (see page 18).**

- 3 Start playback (or select a broadcast station) on the source component.**

- 4 Start recording on the recording component.**

Notes

- When this unit is set in the standby mode, you cannot record between other components connected to this unit.
- The VCR IN signal is not output from the VCR OUT jacks.
- Check the copyright laws in your country to record from records, CDs, radio, etc. Recording of copyrighted material may infringe copyright laws.

If you playback a video source that uses scrambled or encoded signals to prevent it from being dubbed, the picture itself may be disturbed due to those signals.

SOUND FIELD PROGRAM DESCRIPTIONS

This unit is equipped with a variety of precise digital decoders that allow you to enjoy multichannel playback from almost any sound source (stereo or multichannel). This unit is also equipped with a YAMAHA digital sound field processing (DSP) chip containing several sound field programs which you can use to enhance your playback experience. Most of these sound field programs are precise digital recreations of actual acoustic environments found in famous concert halls, music venues, and movie theaters.



The YAMAHA CINEMA DSP modes are compatible with all Dolby Digital, DTS, and Dolby Surround sources. Set the input mode to AUTO (see page 33) to enable this unit to automatically switch to the appropriate digital decoder according to the input signal.

Notes

- This unit's DSP sound field programs are recreations of real-world acoustic environments made from precise measurements taken in the actual hall, etc. Thus you may notice variations in the strength of the reflections coming from the front, back, left and right.
- Feel free to choose a sound field program based on your listening preference, and not purely on the name of the program itself.

For movie/video sources

You can select from the following sound fields when playing movie or video sources. The sound fields marked "MULTI" can be used with multi-channel sources, like DVD, digital TV, etc. Those marked "2-CH" can be used with 2-channel (stereo) sources like TV programs, video tapes, etc.

Remote button	Program	Features	Sources
STEREO 1	STEREO 2ch Stereo	Downmixes multi-channel sources to 2 channels (left and right) or plays back 2-channel sources as is.	
MUSIC 5	MUSIC VIDEO	This program lends an enthusiastic atmosphere to the sound, giving you the feeling you are at an actual jazz or rock concert.	
ENTERTAIN 6	ENTERTAINMENT Game	This program adds a deep and spatial feeling to video game sounds.	
TV THTR 7	TV THEATER Mono Movie	This program is provided for reproducing monaural video sources (such as old movies). The program produces the optimum reverberation to create sound depth using only the presence sound field.	
	TV THEATER Variety/Sports	Though the presence sound field is relatively narrow, the surround sound field employs the sound environment of a large concert hall. This effect enhances the experience of watching various TV programs such as news, variety shows, music programs or sports programs.	
MOVIE 8	MOVIE THEATER Spectacle	CINEMA DSP processing. This program creates the extremely wide sound field of a 70-mm movie theater. It precisely reproduces the source sound in detail, making both the video and the sound field incredibly real. This is ideal for any kind of video source encoded with Dolby Surround, Dolby Digital or DTS (especially large-scale movie productions).	MULTI 2-CH
	MOVIE THEATER Sci-Fi	CINEMA DSP processing. This program clearly reproduces dialog and sound effects in the latest sound form for science fiction films, thus creating a broad and expansive cinematic space amid silence. You can enjoy science fiction films in a virtual-space sound field that includes Dolby Surround, Dolby Digital and DTS-encoded software employing the most advanced techniques.	
	MOVIE THEATER Adventure	CINEMA DSP processing. This program is ideal for precisely reproducing the sound design of the newest 70-mm and multichannel soundtrack films. The sound field is made to be similar to that of the newest movie theaters, so the reverberations of the sound field itself are restrained as much as possible.	
	MOVIE THEATER General	CINEMA DSP processing. This program is for reproducing sounds from 70-mm and multichannel soundtrack films, and is characterized by soft and extensive sound field.	

Remote button	Program	Features	Sources
STANDARD 9	DOLBY DIGITAL SUR. STANDARD	Standard 5.1-channel processing for Dolby Digital sources.	MULTI
	DOLBY DIGITAL SUR. ENHANCED	CINEMA DSP enhanced processing for Dolby Digital sources.	
	DTS SUR. STANDARD	Standard 5.1-channel processing for DTS sources.	
	DTS 96/24 SUR. STANDARD	Standard 5.1-channel processing for 96-kHz/24-bit DTS sources.	
	DTS SUR. ENHANCED	CINEMA DSP enhanced processing for DTS and 96-kHz/24-bit DTS sources.	
	PRO LOGIC SUR. STANDARD	Standard processing for Dolby Surround sources.	2-CH
	PRO LOGIC SUR. ENHANCED	CINEMA DSP enhanced processing for Dolby Surround sources.	
	PRO LOGIC II PLII Movie	Dolby Pro Logic II processing for movie software.	
	PRO LOGIC II PLII Game	Dolby Pro Logic II processing for game software.	

For music sources

You can select from the following sound fields when playing music sources, like CD, FM/AM broadcasting, tapes, etc.

Remote button	Program	Features	Sources
HALL 2	CONCERT HALL	HiFi DSP processing. A classic shoe-box type concert hall with approximately 1700 seats. Pillars and ornate carvings create extremely complex reflections which produce a very full, rich sound.	MULTI 2-CH
JAZZ 3	JAZZ CLUB	HiFi DSP processing. This is the sound field at stage front in "The Bottom Line", a famous New York jazz club. The floor can seat 300 people to the left and right in a sound field offering a real and vibrant sound.	
ROCK 4	ROCK CONCERT	HiFi DSP processing. The ideal program for lively, dynamic rock music. The data for this program was recorded at LA's "hottest" rock club. The listener's virtual seat is at the center-left of the hall.	
ENTERTAIN 6	ENTERTAINMENT Disco	HiFi DSP processing. This program recreates the acoustic environment of a lively disco in the heart of a big city. The sound is dense and highly concentrated. It is also characterized by high-energy, "immediate" sound.	
STEREO 1	STEREO 2ch Stereo	2-channel (left and right) playback.	2-CH
	STEREO Direct Stereo	Use to output stereo sources to only the front left and right speakers without any processing.	
	STEREO 5ch Stereo	Use to increase the output stereo sources (in stereo) from all speakers. This provides a larger sound field and is ideal for background music at parties, etc.	
STANDARD 9	PRO LOGIC II PLII Music	Dolby Pro Logic II processing for music software.	

ADVANCED OPERATIONS

Using the sleep timer

Use this feature to automatically set this unit in the standby mode after a certain amount of time. The sleep timer is useful when you are going to sleep while this unit is playing or recording a source.

■ Setting the sleep timer

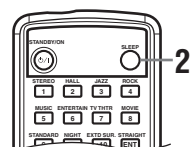

1 Select a source and start playback on the source component.

2 Press **SLEEP** repeatedly on the remote control to set the amount of time.



Each time you press SLEEP, the front panel display changes as shown below. The SLEEP indicator flashes while switching the amount of time for the sleep timer.

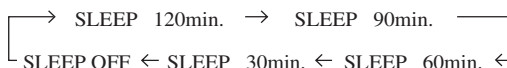

The “SLEEP” indicator lights up in the front panel display after the sleep timer has been set.

Lights



■ Canceling the sleep timer

Press **SLEEP** repeatedly on the remote control until “SLEEP OFF” appears in the front panel display. After a few seconds, “SLEEP OFF” disappears, and the “SLEEP” indicator goes off.



The sleep timer setting can also be canceled by pressing **STANDBY** on the remote control (or **STANDBY/ON** on the front panel) to set this unit to the standby mode.

Enjoying multi-channel software

■ Playing Dolby Digital Surround EX or DTS-ES material

Press **EXTD SUR.** to turn on the Dolby Digital + Matrix 6.1 or DTS + Matrix 6.1 decoder.

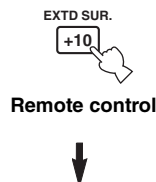

The display changes **AUTO** → **EXTD SUR.:ON** → **OFF** each time **EXTD SUR.** is pressed.

AUTO: Automatically switches Dolby Digital + Matrix 6.1 and DTS + Matrix 6.1 depending on the signal. Virtual surround back speaker does not work for 5.1- channel sources.

EXTD SUR.:ON: Produces 6-channel playback of the input source using the Matrix 6.1 decoder. The virtual surround back speaker can be used when playing a 5.1- channel source.

OFF: Virtual surround back speaker does not work.

Notes

- Some 6.1-channel compatible discs do not have a signal (flag) that this unit can automatically detect. Select “Matrix 6.1” to play these kinds of discs with 6.1-channel sound.
- 6.1-channel playback is not possible even if you press **EXTD SUR.** in the following cases:
 - When effects are turned off.
 - When the unit is reproducing a Dolby Digital **KARAOKE** source.
 - When headphones are connected to the **PHONES** jack.
- The decoding mode resets to **AUTO** when you turn the power of the unit off.

Enjoying 2-channel software

Signals input from 2-channel sources can also be played back on multiple channels.

Press **STANDARD** on the remote control to select the decoder.



Remote control

You can select from the following modes depending on the type of software you are playing and your personal preference.

PRO LOGIC

Standard processing for Dolby Surround sources.

PRO LOGIC ENHANCED

CINEMA DSP enhanced processing for Dolby Surround sources.

PRO LOGIC II Movie

Dolby Pro Logic II processing for movie sources.

PRO LOGIC II Music

Dolby Pro Logic II processing for music sources.

PRO LOGIC II Game

Dolby Pro Logic II processing for games.

■ Listening to high fidelity stereo sound (Direct Stereo)

Direct Stereo allows you to bypass this unit's decoders and DSP processors to enjoy pure high fidelity sound from 2-channel PCM and analog sources.

Press **AMP** to select the AMP mode, then press **STEREO** repeatedly to select "Direct Stereo".



Remote control



Direct Stereo

Notes

- To avoid unexpected noise, do not play DTS-encoded CDs in this mode.
- When multi-channel signals (Dolby Digital and DTS) are input, this unit automatically switches to the corresponding analog input. (When DTS is selected as an input mode, no sound will be heard.)
- No sound will be output from the subwoofer.
- TONE CONTROL (page 19) and SET MENU (page 36) settings are not effective.
- The front panel display automatically dims.



You can enjoy 2-channel stereo playback from multi-channel sources when "2ch Stereo" is selected (see page 21).

Virtual CINEMA DSP

Virtual CINEMA DSP allows you to enjoy DSP sound field programs without surround speakers. It creates virtual speakers to reproduce the natural sound field. If SURR L/R SP in SPEAKER SET is set to "NONE", Virtual CINEMA DSP activates automatically whenever you select a CINEMA DSP sound field program.

Note

Virtual CINEMA DSP will not activate, even when Surround L/R is set to "None" (see page 38), in the following cases:

- When the 5ch Stereo, 2ch Stereo, Direct Stereo, or SUR. STANDARD program is selected.
- When the sound effect is turned off.
- When headphones are connected.

Selecting input modes

This unit comes with a variety of input jacks. Do the following to select the type of input signals you want to use.

Use this feature to designate the input mode for sources connected to the DIGITAL INPUT jacks when you turn on this unit (see page 42 for details about the input mode).

Note

You cannot change the input mode when INPUT MODE of SET MENU is set to "FIX". In this case, change the setting to "AUTO" or "LAST" (see page 42).

1 Select the input source.

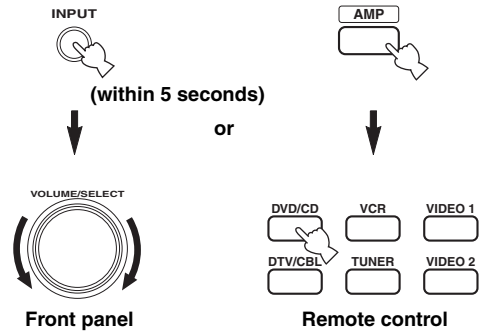

Note

If no operation is performed within 5 seconds of pressing **INPUT** or **VOLUME/SELECT** is pressed on the front panel, the function of **VOLUME/SELECT** switches back to volume level adjustment. If this happens, "VOLUME" appears in the front panel display for a few seconds.

- 2 Press INPUT repeatedly until the desired input mode is shown in the front panel display.**

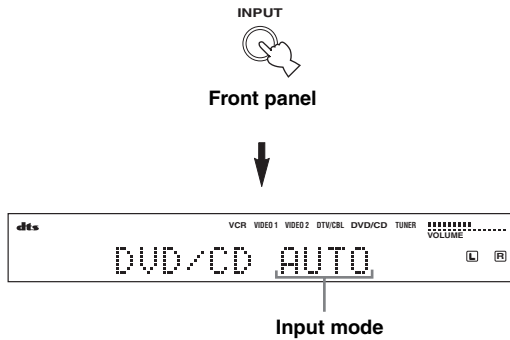

- AUTO** Automatically selects input signals in the following order:
1) Digital signals*
2) Analog signals
- DTS** Selects only digital signals encoded in DTS. If no DTS signals are input, no sound is output.
- ANALOG** Selects only analog signals. If no analog signals are input, no sound is output.

* If this unit detects a Dolby Digital or DTS signal, the decoder automatically switches to the appropriate sound field program.



You can adjust the default input mode this unit selects when the power is turned on with the SETTING parameter in INPUT MODE (see page 42).

Notes

- When the SETTING parameter in INPUT MODE is set to “FIX”, you cannot switch the input mode by pressing INPUT (see page 42).
- When playing a disc encoded with Dolby Digital or DTS on some LD or DVD players, there is a delay in sound output for a moment when playback resumes after a search, because the unit must select the digital signal again.
- When playing an LD source that has not been digitally recorded, the unit may not output any sound for some LD players. In this case, set the input mode to Analog.
- If you attempt to search (forward or backward) during playback of a DTS-encoded disc, noise may occur periodically. If this happens, set the input mode to DTS.
- When you play DTS-encoded CD/LDs with the input mode set to AUTO, this unit automatically switches to the DTS decoding mode. The unit remains in DTS mode (and the **dts** indicator may flash) for a few seconds after playback of the DTS source is complete. To manually release the DTS mode, press INPUT MODE to reselect AUTO.
- If the digital output data of the player has been processed in any way, you may not be able to perform DTS decoding even if you make a digital connection between this unit and the player.

■ Displaying information about the input source

You can display the type, format and sampling frequency of the current input signal.

- 1 Press AMP.**

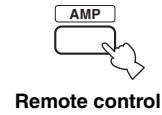

- 2 Press STRAIGHT/EFFECT so that “STRAIGHT” appears in the display.**

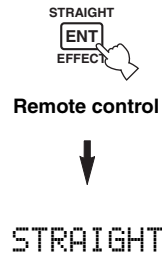

- 3 Press Δ / ∇ to display the following information about the input signal.**

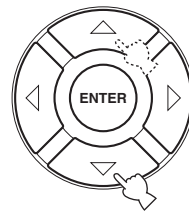

- (Format) Signal format display. When the unit cannot detect a digital signal it automatically switches to analog input.
- in Number of source channels in the input signal. For example, a multi-channel soundtrack with 3 front channels, 2 surround channels and LFE, is displayed as “3/2/LFE”.
- fs Sampling frequency. When the unit is unable to detect the sampling frequency “Unknown” appears.
- rate Bit rate. When the unit is unable to detect the bit rate “Unknown” appears.
- flg Flag data encoded with DTS or Dolby Digital signals that cue this unit to automatically switch decoders.

Manually adjusting speaker levels

You can adjust the output level of each speaker while listening to a music source. Please note that this operation will override the level adjustments made in the Speaker Level section of BASIC SETUP (see page 17) and “Using the test tone” (page 35).

1 Press AMP to select the AMP mode.

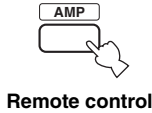

2 Press LEVEL repeatedly to select the speaker you want to adjust.



FRONT L	Front left speaker level
CENTER	Center speaker level
FRONT R	Front right speaker level
SUR.R	Surround right speaker level
SUR.L	Surround left speaker level
SWFR	Subwoofer level



Once you press LEVEL, you can also select the speaker by pressing \triangle / ∇ on the remote control.

3 Press \triangle / ∇ to adjust the speaker output level (Control range: -10 to +10 dB).

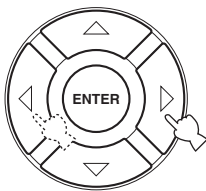

Using the test tone

You can use the test tone feature to manually balance your speaker levels. Please note that this operation will override the level adjustments made in the Speaker Level section of BASIC SETUP (page 17). Use the test tone to set speaker levels so that the volume from each speaker is identical when heard from your listening position.

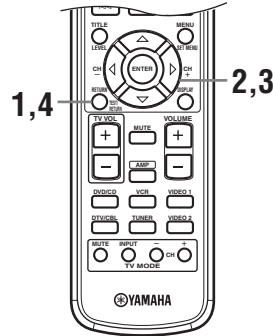

1 Press TEST/RETURN on the remote control.

The unit will output a test tone.



2 Press \triangle / ∇ repeatedly on the remote control to select the speaker you want to adjust.

TEST LEFT	Front left speaker
TEST CENTER	Center speaker
TEST RIGHT	Front right speaker
TEST SUR. R	Surround right speaker
TEST SUR. L	Surround left speaker
TEST SUBWOOFER	Subwoofer

3 Press \triangle / ∇ to adjust speaker volumes.

4 Press TEST/RETURN when you have completed your adjustment.

The test tone stops.

Note

You cannot enter test mode if headphones are connected to the PHONES jack. Remove the headphones from the PHONES jack.

SET MENU

You can use the following parameters in SET MENU to adjust a variety of system settings and customize the way this unit operates. Change the initial settings (indicated in bold under each parameter) to reflect the needs of your listening environment.

■ BASIC SETUP

Use to quickly setup basic system parameters (see page 16).

■ MANUAL SETUP

Use to manually adjust speaker and system parameters.

1 SOUND MENU

Use to manually adjust any speaker setting, alter the quality and tone of the sound output by the system or compensate for video signal processing delays when using LCD monitors or projectors.



Most of the parameters described in SOUND MENU are set automatically when you perform "BASIC SETUP" (see page 16). You can use SOUND MENU to make further adjustments.

Item	Features	Page
A)SPEAKER SET	Selects the size of each speaker, the speakers for low-frequency signal output, and the cross over frequency.	38
B)SP LEVEL	Adjusts the output level of each speaker.	39
C)SP DISTANCE	Adjusts the delay time of each speaker.	40
D)CENTER GEQ	Adjusts the tonal quality of the center speaker.	40
E)LFE LEVEL	Adjusts the output level of the LFE channel for Dolby Digital or DTS signals.	40
F)D. RANGE	Adjusts the dynamic range for Dolby Digital or DTS signals.	41
G)AUDIO SET	Customizes the muting level and audio delay.	41

2 INPUT MENU

Use to reassign digital input and select the input mode.

Item	Features	Page
A)INPUT ASSIGN	Assigns jacks according to the component to be used.	41
B)INPUT MODE	Selects the initial input mode of the source.	42

3 OPTION MENU

Use to adjust the optional system parameters.

Item	Features	Page
A)DISPLAY SET	Adjusts the brightness of the display and converts video signals.	42
B)MEMORY GUARD	Locks sound field program parameters and other SET MENU settings.	43
C)PARAM. INI	Initializes the parameters of a group of sound field programs.	43
D)TUNER SET	Switches frequency spacing.*a	43
D)SCART SET	Turns on this unit when a component connected using a SCART cable is turned on.*b	43

*a: D)TUNER SET is only available for Asia and General models.

*b: D)SCART SET is only available for U.K. and Europe models.

Changing parameter settings

You can enjoy good quality sound with the factory-set parameters. Although you do not have to change the initial settings, you can change some of the parameters to better suit the input source or your listening room. Use the remote control to access and adjust each parameter.

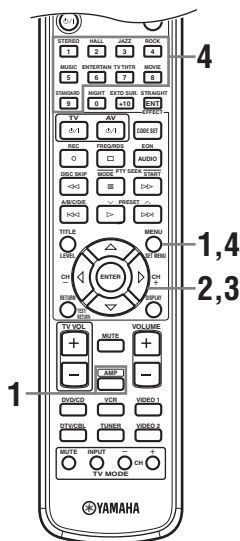

You can change SET MENU parameters while the unit is reproducing sound.

Note

You cannot change some SET MENU parameters while the unit is in either cinema or music night listening mode.

1 Press AMP, then press SET MENU to enter SET MENU.

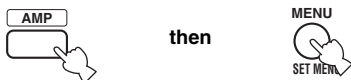

“SET MENU” is displayed on both the monitor and front panel of this unit.

The explanations in this document are based on the Screen Menu. The characters shown in the front panel display may differ from those on the Screen Menu.

2 Press Δ / ∇ repeatedly to select a menu, then press ENTER.

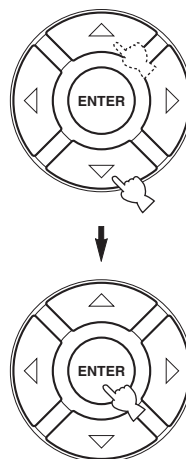

- The number of levels each menu contains may differ. If the menu you selected contains a sub menu, press ENTER to enter the desired sub menu.
- Press TEST/RETURN to return to the upper level menu.

3 Press \triangleleft / \triangleright repeatedly to change the setting for the item you want to adjust.

4 To exit, press SET MENU, or just press one of the sound field program group buttons when finished.

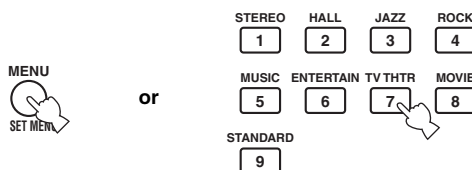

Note

You cannot change parameter values when Memory Guard is set to “ON”. If you want to change the parameter values, set Memory Guard to “OFF” (see page 43).

Memory back-up

The memory back-up circuit prevents the stored data from being lost even if this unit is set in the standby mode, the power cord is disconnected from the AC outlet, or the power supply is temporarily cut due to power failure. However, if the power is cut for more than one week, the parameter values will return to the factory settings. If this happens, edit the parameter value again.

1 SOUND MENU

Use this menu to manually adjust any speaker setting.



■ Speaker set A) SPEAKER SET

Use to manually adjust any speaker setting.



If you are not satisfied with the bass sounds from your speakers, you can change these settings according to your preference.

Center speaker CENTER SP

Choices: NONE, **SML**, LRG

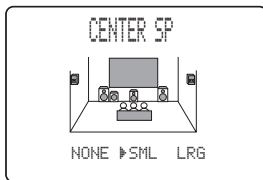

- Select NONE if you do not have a center speaker. The unit directs all of the center channel signal to the front left and right speakers.
- Select SML if you have a small center speaker. The unit directs the low-frequency signals of the center channel to the speakers selected with “LFE/BASS OUT”.
- Select LRG if you have a large center speaker. The unit directs the entire range of the center channel signal to the center speaker.

Front speakers FRONT SP

Choices: SMALL, **LARGE**

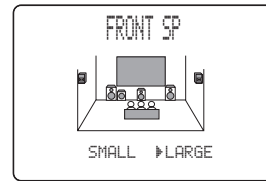

- Select SMALL if you have small front speakers. The unit directs the low-frequency signals of the front channel to the speakers selected with “LFE/BASS OUT”.
- Select LARGE if you have large front speakers. The unit directs the entire range of the front left and right channel signals to the front left and right speakers.

Surround left/right speakers SURR L/R SP

Choices: NONE, **SML**, LRG

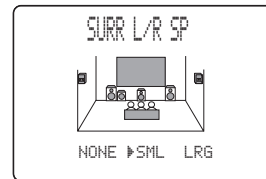

- Select NONE if you do not have surround speakers. This will set the unit to the Virtual CINEMA DSP mode (see page 33).
- Select SML if you have small surround left and right speakers. The low-frequency signals of the surround channel are directed to the speakers selected with “LFE/BASS OUT”.
- Select LRG if you have large surround left and right speakers. The entire range of the surround channel signal is directed to the surround left and right speakers.

Bass out LFE/BASS OUT

Low-frequency (bass) signals can be directed to the subwoofer and/or the front left and right speakers according to the characteristics of your system. This setting also determines the routing of the LFE (low-frequency effect) signals found in Dolby Digital or DTS sources.

Choices: SWFR, FRNT, **BOTH**

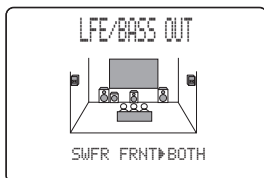

- Select SWFR if you connect a subwoofer. LFE and low-frequency signals from other channels are directed to the subwoofer according to the speaker settings.
- Select FRNT if you do not use a subwoofer. LFE and low frequency signals from other channels are directed to the front speakers according to the speaker settings (even if you have previously set front speakers to SML).
- Select BOTH if you connect a subwoofer and you want to output low-frequency signals from front channels to both the front speakers and subwoofer. LFE and low-frequency signals from other channels are also directed to the subwoofer according to the speaker settings. Use this function to reinforce low-frequency signals using the subwoofer when playing back sources such as CDs.

Cross over CROSS OVER

Use this feature to select a cross-over (cut-off) frequency for all low-frequency signals. All frequencies below the selected frequency will be sent to the subwoofer.

Choices: 40Hz, 60Hz, **80Hz**, 90Hz, 100Hz, 110Hz, 120Hz, 160Hz, 200Hz

**Subwoofer phase** SUBWOOFER PHASE

If bass sounds are lacking or unclear, use this feature to switch the phase of your subwoofer.

Choices: **NORMAL**, REVERSE

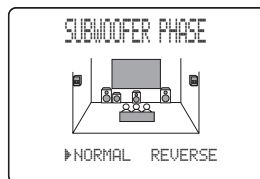

- Select NORMAL if you do not want to reverse the phase of your subwoofer.
- Select REVERSE to reverse the phase of your subwoofer.

Speaker level B)SPEAKER LEVEL

Use these settings to manually balance the speaker levels between the front left or surround left speakers and each speaker selected in SPEAKER SET (page 38).

Choices: -10 to +10 dB

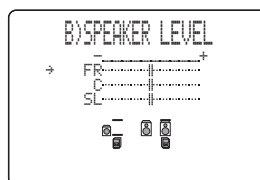

- **FR** adjusts the balance of the front left and front right speakers.
- **C** adjusts the balance of the front left and center speakers.
- **SL** adjusts the balance of the front left and surround left speakers.
- **SR** adjusts the balance of the surround left and surround right speakers.
- **SWFR** adjusts the balance of the front left speaker and subwoofer.



To calibrate, use the test tone feature (see page 35).

■ **Speaker distance** C)SP DISTANCE

Use this feature to manually input the distance of each speaker and adjust the delay applied to respective channel. Ideally, each speaker should be the same distance from the main listening position. However, this is not possible in most home situations. Thus, a certain amount of delay must be applied to the sound from each speaker so that all sound will arrive at the listening position at the same time.

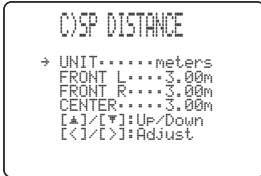

Unit UNIT

Choices: **meters** (m), feet (ft)

Initial setting:

U.S.A. and Canada models: feet (ft)

Other models: meters (m)

- Select meters to input speaker distances in meters.
- Select feet to input speaker distances in feet.

Speaker distances

Choices: 0.3 to 24.00 m (1 to 80 ft)

- **FRONT L** adjusts the distance of the front left speaker. Initial setting: 3.0 m (10.0 ft)
- **FRONT R** adjusts the distance of the front right speaker. Initial setting: 3.0 m (10.0 ft)
- **CENTER** adjusts the distance of the center speaker. Initial setting: 3.0 m (10.0 ft)
- **SURR L** adjusts the distance of the surround left speaker. Initial setting: 3.0 m (10.0 ft)
- **SURR R** adjusts the distance of the surround right speaker. Initial setting: 3.0 m (10.0 ft)
- **SWFR** adjusts the distance of the subwoofer. Initial setting: 3.0 m (10.0 ft)

■ **Center graphic equalizer** D)CENTER GEO

Use this feature to adjust the built-in 5-band graphic equalizer for the center channel so that the tonal quality of the center speaker matches that of the front speakers. You can make adjustments listening to the currently selected source component or a test tone.

You can adjust 5 frequency bands: 100Hz, 300Hz, 1kHz, 3kHz, 10kHz

Choices: -6 to +6 dB

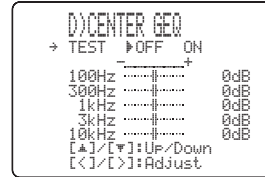

- Select ON to output test tones from the front left and center speakers, and adjust the tonal quality of the center speaker.
- Select OFF to stop the test tone and output the currently selected source component.
- Press ^ / v to select a frequency band.
- Press < / > to adjust the selected frequency band.

■ **Low-frequency effect level** E)LFE LEVEL

Use to adjust the output level of the LFE (low-frequency effect) channel according to the capacity of your subwoofer or headphones. The LFE channel carries low-frequency special effects which are only added to certain scenes. This setting is effective only when this unit decodes Dolby Digital or DTS signals.

Choices: -20 to 0 dB



Speaker SPEAKER

Select to adjust the speaker LFE level.

Headphone HEADPHONE

Select to adjust the headphone LFE level.

Note

Depending on the settings of “LFE LEVEL”, some signals may not be output from the SUBWOOFER OUTPUT jack.

Dynamic range F)DYNAMIC RANGE

Use to select the amount of dynamic range compression to be applied to your speakers or headphones. This setting is effective only when the unit is decoding Dolby Digital and DTS signals.

Choices: MIN (minimum), STD (standard),

MAX (maximum)

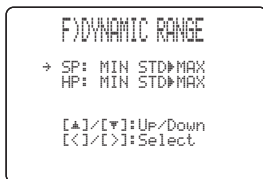

Speaker SP

Select to adjust the speaker compression.

Headphone HP

Select to adjust the headphone compression.

- Select MIN if you regularly listen at low volume levels.
- Select STD for general use.
- Select MAX to preserve the greatest amount of dynamic range.

Audio set G)AUDIO SET

Use to customize this units overall audio settings.



Audio mute AUDIO MUTE

Use to adjust how much the mute function reduces the output volume.

Choices: **MUTE**, -20 dB

- Select MUTE to completely halt all output of sound.
- Select -20 dB to reduce the current volume by 20 dB.

Audio delay AUDIO DELAY

Use to delay the sound output and synchronize it with the video image. This may be necessary when using certain LCD monitors or projectors.

Choices: **0** to 160 ms

2 INPUT MENU

Use this menu to manually adjust any input setting.



Input assignment A)INPUT ASSIGN

You can assign jacks according to the component to be used if this unit's initial settings do not correspond to your needs. Change the following parameters to reassign the respective jacks and effectively connect more components. Once the inputs have been reassigned, you can select the corresponding component by using INPUT on the front panel or the input selector buttons on the remote control.

For OPTICAL INPUT jacks 1 and 2

Choices: DVD/CD, VIDEO1, VCR, DTV/CBL

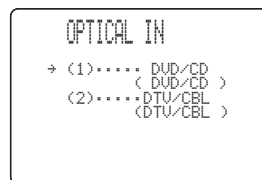

Note

OPTICAL IN(2) cannot be assigned to an item already set to OPTICAL IN(1). If you want to assign OPTICAL IN(2), change the selection for OPTICAL IN(1). If the above settings are incorrect, "--" appears in the display.

For COAXIAL INPUT jack 3

Choices: VIDEO1, VCR, DTV/CBL, DVD/CD



Note

COAXIAL IN(3) cannot be assigned to an item already set to OPTICAL IN(1) or OPTICAL IN(2). If you want to assign COAXIAL IN(3), change the selection for OPTICAL IN(1) or OPTICAL IN(2). If the above settings are incorrect, "--" appears in the display.

■ Input mode B>INPUT MODE

Use this feature to designate the input mode for sources connected to the DIGITAL INPUT jacks when you turn on this unit (see page 33 for details about the input mode).

Choices: **AUTO**, LAST, FIX



- Select **AUTO** if you want “Auto” to be set whenever you turn on this unit’s power.
- Select **LAST** to set this unit to automatically select the last input mode used for that source.
- Select **FIX** to fix the input mode used for that source.

3 OPTION MENU

Use this menu to manually adjust the optional system settings.

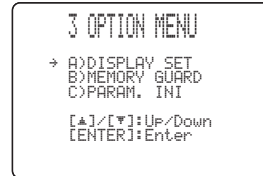

(Asia and General models)



(Europe and U.K. models)



■ Display set A>DISPLAY SET



Dimmer DIMMER

Use to adjust the brightness of the front panel display.

Choices: -4 to **0**

MENU shift MENU SHIFT

Use to adjust the vertical position of the Screen Menu.

Choices: -5 (upward) to +5 (downward)

- Press - to raise the position of the Screen Menu.
- Press + to lower the position of the Screen Menu.

Memory guard B)MEMORY GUARD

Use this feature to prevent accidental changes to DSP program parameter values and other system settings.

Choices: **OFF**, **ON**

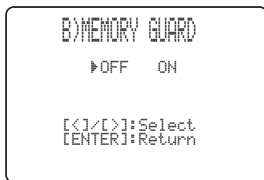

Select ON to protect:

- DSP program parameters
- All SET MENU items
- All speaker levels

Note

When “MEMORY GUARD” is set to ON, you cannot use the test tone or select any other SET MENU items.

Parameter initialization C)PARAM. INI

Use this feature to initialize the parameters for each sound field program within a sound field program group. When you initialize a sound field program group, all of the parameter values within that group revert to their initial settings.

Press the corresponding numeric button for the sound field program that you want to initialize.

An asterisk (*) next to a program number means that the parameter values have been changed from their initial settings.

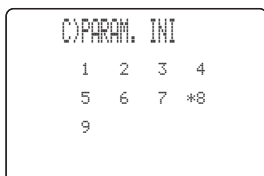

Notes

- You cannot automatically revert to the previous parameter settings once you initialize a sound field program group.
- You cannot separately initialize individual sound field programs.
- You cannot initialize any program groups when “MEMORY GUARD” is set to ON.

Tuner set D)TUNER SET

Use this feature to adjust the frequency spacing for the tuner. The new setting becomes active the next time the power is turned on.



Choices: **AM: 9kHz, FM: 50kHz** and

AM: 10kHz, FM: 100kHz

- Select AM: 9kHz, FM: 50kHz to set the AM band to 9kHz and the FM band to 50kHz.
- Select AM: 10kHz, FM: 100kHz to set the AM band to 10kHz and the FM band to 100kHz.

Note

This feature is only available when using Asia and General models.

Scart set D)SCART SET

Use this feature to select whether you want signals carried via SCART connections to pass through this unit when it is set to the standby mode.

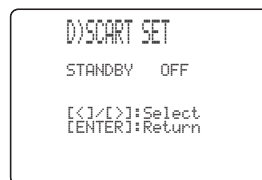
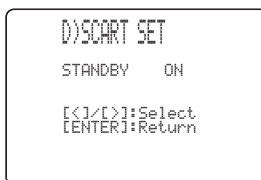

Choices: **ON**, **OFF**

- Select ON if you want to allow signals to pass through this unit when it is in standby mode. (For example, if this unit is connected via its SCART connectors between your TV and VCR, the TV signals can pass through to the VCR even when this unit is in the standby mode.)
- Select OFF if you do not want signals to pass through this unit when it is in standby mode.

Note

This feature is only available when using Europe and U.K. models.

REMOTE CONTROL FEATURES

In addition to controlling this unit, the remote control can operate other A/V components made by YAMAHA and other manufacturers. To control other components, set up the remote control with the appropriate remote control codes.

Control area

■ Controlling this unit

The shaded areas below can be used to control this unit when the AMP mode is selected. Press AMP to select the AMP mode.

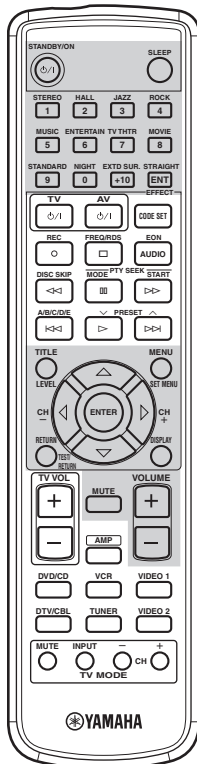

■ Controlling other components

The shaded areas below can be used to control other components. Each button has a different function depending on the selected components. Select the component you want to control by pressing an input selector button. The name of the selected component appears in the display window.

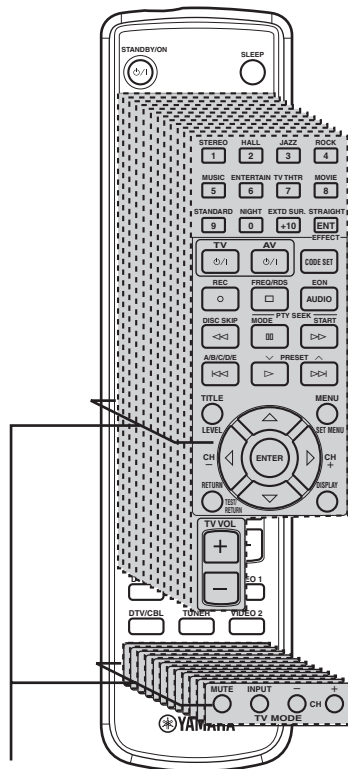

Component control area

You can control up to 11 different components by setting appropriate remote control codes (see page 45).

Setting remote control codes

Once you set the appropriate remote control codes, you can use this remote to control your other components. Note that some buttons may not correctly operate the selected component. Use the input selector buttons to select the component you want to operate. The remote control automatically switches to the appropriate control mode for that component.

Default codes

The following table shows the default component (Library: component category) and the remote control code for each area.

Input area	Manufacturer	Code
TV (DTV/CBL)	YAMAHA	299
VCR	YAMAHA	399
DVD (DVD/CD)	YAMAHA	699

Note

You may not be able to operate your YAMAHA component even if a YAMAHA remote control code is initially set as listed above. In this case, try to set another YAMAHA remote control code.

Setting a code

1 Hold down **CODE SET** while doing steps 2 and 3.



2 Press an input selector button to select the source component you want to set up.

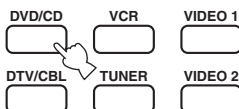

3 Press the numeric buttons to enter the three-digit remote control code for the component to be used, then release **CODE SET**.

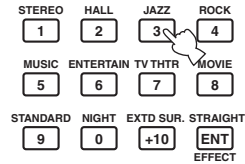

Refer to “LIST OF REMOTE CONTROL CODES” at the end of this manual.



To reset an input area’s remote control code to the factory default, input the default code (see “Default codes” above) in step 3.

Notes

- If the manufacturer of your component has more than one code, try each of them until you find the correct one.
- If you wait for more than 10 seconds during step 3, the setup process is canceled. If this happens, start over from step 2.
- Replace the batteries frequently. The settings may be lost after two minutes without power supply.
- If the remote control code is successfully set, “Code Set OK” appears in the front panel display of this unit. If the setting is not successful, “Code Set NG” appears.

Controlling other components

You can operate other components if you have set the remote control code for your component in the remote control. Please note that some buttons may not operate the component as expected. When you select an input source, the remote control automatically switches to the mode for operating that component.

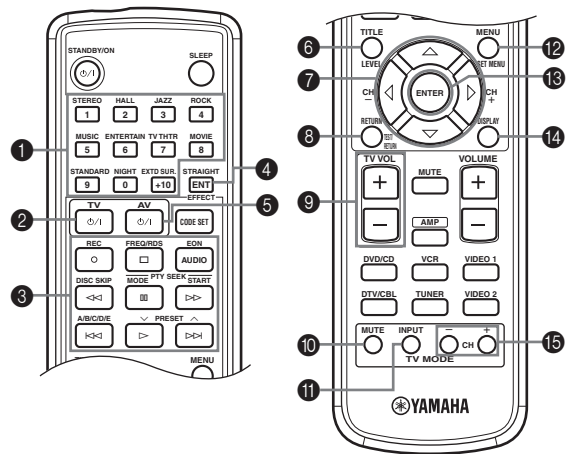

	DVD player	VCR	TV, digital/cable TV	Tuner
① 1-9, 0, +10	Numeric buttons	Numeric buttons	Numeric buttons	Preset stations (1-8)
② TV	TV power *2	TV power *2	TV power *2	TV power *2
③ REC/DISC SKIP	Disc skip	Rec *3	VCR rec	
▷	Play	Play *3	VCR play	Preset down
◁◁	Search backward	Search backward *3	VCR search backward	
▷▷	Search forward	Search forward *3	VCR search forward	
AUDIO	Audio			
⏸	Pause	Pause *3	VCR pause	
▷▷▷	Skip forward			Preset up
◁◁◁	Skip backward			A/B/C/D/E
□	Stop	Stop *3	VCR stop	
④ ENT	Title/Index		Enter/12	
⑤ AV	Power *1	Power *1	VCR power	
⑥ TITLE	Title			
⑦ ▲	Up			
▼	Down			
CH +/▷	Right	VCR channel up		
CH -/◁	Left	VCR channel down		
⑧ RETURN	Return			
⑨ TV VOL +	TV volume up *2	TV volume up *2	TV volume up *2	TV volume up *2
TV VOL -	TV volume down *2	TV volume down *2	TV volume down *2	TV volume down *2
⑩ TV MUTE	TV mute *2	TV mute *2	TV mute	TV mute *2
⑪ TV INPUT	TV input *2	TV input *2	TV input	TV input *2
⑫ MENU	Menu			
⑬ ENTER	Enter			
⑭ DISPLAY	Display			
⑮ TV CH +	TV channel up *2	TV channel up *2	TV channel up	TV channel up *2
TV CH -	TV channel down *2	TV channel down *2	TV channel down	TV channel down *2

*1 This button functions only when the original remote control of the component has a POWER button.

*2 These buttons can operate your TV without switching the input if the remote control code is set in DTV/CBL.

*3 These buttons can operate your VCR without switching the input to VCR if the remote control code is set in VCR.

EDITING SOUND FIELD PARAMETERS

What is a sound field

What really creates the rich, full tones of a live instrument are the multiple reflections from the walls of the room. In addition to making the sound “live”, these reflections enable us to tell where the player is situated, and the size and shape of the room in which we are sitting.



For details on how to change parameter settings, see page 37.

■ Elements of a sound field

In any environment, in addition to the direct sound coming straight to our ears from the player’s instrument, there are two distinct types of sound reflections that combine to make up the sound field:

Early reflections

Reflected sounds reach our ears extremely rapidly (50 ms – 100 ms after the direct sound), after reflecting from one surface only – for example, from the ceiling or a wall. Early reflections actually add clarity to the direct sound.

Reverberations

These are caused by reflections from more than one surface – walls, ceiling, the back of the room – so numerous that they merge together to form a continuous sonic “afterglow”. They are non-directional, and lessen the clarity of the direct sound.

Direct sound, early reflections and subsequent reverberation taken together help us to determine the subjective size and shape of the room, and it is this information that the digital sound field processor reproduces in order to create sound fields.

If you could create the appropriate early reflections and subsequent reverberations in your listening room, you would be able to create your own listening environment. The acoustics in your room could be changed to those of a concert hall, a dance floor, or virtually any size room at all. This ability to create sound fields at will is exactly what YAMAHA has done with the digital sound field processor.

Sound field parameter descriptions

You can adjust the values of certain digital sound field parameters so the sound fields are recreated accurately in your listening room. Not all of the following parameters are found in every program.

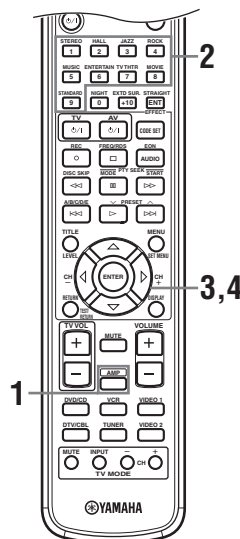

1 Press AMP on the remote control.



2 Press one of the sound field program group buttons to select the desired sound field program.

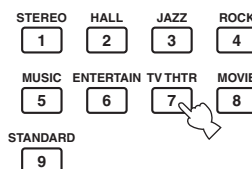

- 3** Press \triangle / ∇ repeatedly to access the sound field program parameters.

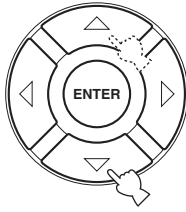

- 4** Press \triangle / ∇ repeatedly to adjust the sound field parameter.

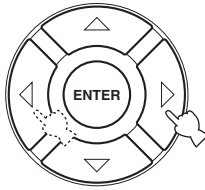

- 5** To change parameter values for a different sound field, repeat steps 2 through 4.

Note

You cannot change parameter values when Memory Guard is set to "ON". If you want to change the parameter values, set Memory Guard to "OFF" (see page 43).

■ **DSP LEVEL**

Function: This parameter adjusts the level of all the DSP effect sounds within a narrow range.

Description: Depending on the acoustics of your listening room, you may want to increase or decrease the DSP effect level relative to the level of the direct sound.

Control range: -6 to +3 dB

■ **DELAY**

Function: This parameter changes the apparent distance from the source sound by adjusting the delay between the direct sound and the first reflection heard by the listener.

Description: The smaller the value, the closer the sound source seems to the listener. The larger the value, the farther it seems. For a small room, set to a small value. For a large room, set to a large value.

Control range: 1 to 99 ms

For 5ch Stereo

Function: These parameter adjusts the volume level for each channel in 5-channel stereo mode.

Control Range: 0 to 100%

- **CT LEVEL (Center level)**
- **SL LEVEL (Surround left level)**
- **SR LEVEL (Surround right level)**

For PRO LOGIC II Music

■ **PANORAMA**

Function: Extends the front stereo image to include the surround speakers for wraparound effect.

Choices: OFF/ON, initial setting is OFF.

■ **DIMENSION**

Function: Gradually adjusts the sound field either towards the front or towards the rear.

Control range: -3 (towards the rear) to +3 (towards the front), initial setting is STD (standard).

■ **CT WIDTH (Center width)**

Function: Adjusts the center image from all three front speakers to varying degrees. A larger value adjusts the center image towards the front left and right speakers.

Control range: 0 (center channel sound is output only from center speaker) to 7 (center channel sound is output only from front left and right speakers), initial setting is 3.

TROUBLESHOOTING

Refer to the chart below when this unit does not function properly. If the problem you are experiencing is not listed below or if the instruction below does not help, set this unit to the standby mode, unplug the power cord from the outlet, and contact the nearest authorized YAMAHA dealer or service center.

■ General

Problem	Cause	Remedy	Refer to page
This unit fails to turn on when STANDBY/ON is pressed, or enters in the standby mode soon after the power has been turned on.	The power cord is not connected or the plug is not completely inserted.	Connect the power cord firmly.	—
	The protection circuitry has been activated.	Make sure all speaker wire connections on this unit and on all speakers are secure and that the wire for each connection does not touch anything other than its respective connection.	9, 10
	This unit has been exposed to a strong external electric shock (such as lightning and strong static electricity).	Set this unit in the standby mode, disconnect the power cord, plug it back in after 30 seconds, then use it normally.	—
No sound	Incorrect input or output cable connections.	Connect the cables properly. If the problem persists, the cables may be defective.	9, 11
	Input Mode is set to DTS or ANALOG.	Select AUTO.	33—34
	No appropriate input source has been selected.	Select an appropriate input source by pressing INPUT, then rotating VOLUME/SELECT or using the input selector buttons.	18
	Speaker connections are not secure.	Secure the connections.	9
	The volume is turned down.	Turn up the volume.	—
	The sound is muted.	Press MUTE or any operation button on this unit to cancel mute and adjust the volume.	19
	If you are playing an LD source, the player may not output digital signals if the LD source was not digitally recorded.	Set the Input Mode to ANALOG.	33—34
	The Input Mode is set to ANALOG while playing a source encoded with a DTS signal.	Set the Input Mode to AUTO or DTS.	33—34
	Signals this unit cannot reproduce are being received from a source component e.g.: a CD-ROM.	Play a source whose signals this unit can reproduce.	—
The sound suddenly goes off.	The protection circuitry has been activated because of a short circuit, etc.	Check the speaker wires are not touching each other and then turn this unit back on.	—
	The sleep timer has turned the unit off.	Turn on the power, and play the source again.	—
	The sound is muted.	Press MUTE to cancel a mute.	19
Only the speaker on one side can be heard.	Incorrect cable connections.	Connect the cables properly. If the problem persists, the cables may be defective.	9, 11
	Incorrect balance settings in SET MENU.	Adjust the SPEAKER LEVEL settings.	17, 39
Only the center speaker outputs substantial sound.	When playing a monaural source with a CINEMA DSP program, the source signal is directed to the center channel, and the front and surround speakers output effect sounds.		

Problem	Cause	Remedy	Refer to page
No sound from the effect speakers.	The sound field programs are turned off.	Press STRAIGHT/EFFECT to turn them on.	21
	You are using a source or program combination that does not output sound from all channels.	Try another sound field program.	28
No sound from the center speaker.	The output level of the center speaker is set to minimum.	Raise the level of the center speaker.	17, 39
	“CENTER SP” in SET MENU is set to NONE.	Select the appropriate setting for the center speaker.	38
	One of the Hi-Fi DSP programs (except for 5ch Stereo) has been selected.	Try another sound field program.	28
No sound from the surround speakers.	The output level of the surround speakers is set to minimum.	Raise the output level of the surround speakers.	17, 39
	“SURR L/R SP” in SET MENU is set to NONE.	Select the appropriate setting for the surround left and right speakers.	38
	A monaural source is being played with STRAIGHT.	Press STRAIGHT/EFFECT to turn on the sound fields.	—
No sound from the subwoofer.	“LFE/BASS OUT” in SET MENU is set to FRNT when a Dolby Digital or DTS signal is being played.	Select SWFR or BOTH.	39
	“LFE/BASS OUT” in SET MENU is set to SWFR or FRNT when a 2-channel source is being played.	Select BOTH.	39
	The source does not contain low bass signals.		
Dolby Digital or DTS sources cannot be played. (Dolby Digital or DTS indicator in the front panel display does not light up.)	The connected component is not set to output Dolby Digital or DTS digital signals.	Make an appropriate setting following the operations instructions for your component.	—
	Input Mode is set to ANALOG.	Set Input Mode to AUTO or DTS.	33—34
A “humming” sound can be heard.	Incorrect cable connections.	Firmly connect the audio plugs. If the problem persists, the cables may be defective.	—
The volume level cannot be increased, or the sound is distorted.	The component connected to this unit’s VCR OUT jack is turned off.	Turn on the power to the component.	—
The sound effect cannot be recorded.	It is not possible to record the sound effect with a recording component.		
A source cannot be recorded by a digital recording component connected to this DIGITAL OUTPUT jack.	The source component is not connected to this unit’s DIGITAL INPUT jacks.	Connect the source component to the DIGITAL INPUT jacks.	11
	Some components cannot record the Dolby Digital or DTS sources.		
A source cannot be recorded by an analog component connected to the VCR OUT jacks.	The source component is not connected to this unit’s DVD/CD, DTV/CBL, VIDEO 1, VCR IN or VIDEO 2 jacks.	Connect the source component to any of these jacks.	11
The sound field parameters and some other settings on this unit cannot be changed.	“MEMORY GUARD” in SET MENU is set to ON.	Select OFF.	43

Problem	Cause	Remedy	Refer to page
This unit does not operate properly.	The internal microcomputer has been frozen by an external electric shock (such as lightning or excessive static electricity) or by a power supply with low voltage.	Disconnect the AC power cord from the outlet and then plug it in again after about 30 seconds.	—
“CHECK SP WIRES” appears in the front panel display.	Speaker cables are short circuited.	Make sure all speaker cables are connected correctly.	9
There is noise interference from digital or high-frequency equipment, or this unit.	This unit is too close to digital or high-frequency equipment.	Move this unit further away from such equipment.	—
The picture is disturbed.	The video source uses scrambled or encoded signals to prevent dubbing.		
This unit suddenly switches to the standby mode.	The internal temperature became too high and the overheat protection circuitry was activated.	Wait until this unit cools down and then turn it back on.	—
The whirring of the fan can occasionally be heard.	This unit is fitted with a fan for cooling purposes. The fan automatically operates when the temperature inside the unit becomes too hot, or when the unit is turned on.		

■ Tuner

Problem		Cause	Remedy	Refer to page	
FM	FM stereo reception is noisy.	The characteristics of FM stereo broadcasts may cause this problem when the transmitter is too far away or the antenna input is poor.	Check the antenna connections. Try using a high-quality directional FM antenna.	14	
			Use the manual tuning method.	23	
	There is distortion, and clear reception cannot be obtained even with a good FM antenna.	There is multipath interference.	Adjust the antenna position to eliminate multipath interference.	—	
			The station is too weak.	Use a high-quality directional FM antenna.	—
The desired station cannot be tuned in with the automatic tuning method.		Use the manual tuning method.	23		
Previously preset stations can no longer be tuned in.	This unit has been disconnected for a long period.	Preset the stations again.	24		
AM	The desired station cannot be tuned in with the automatic tuning method.	The signal is weak or the antenna connections are loose.	Tighten the AM loop antenna connections and orient it for best reception.	—	
			Use the manual tuning method.	23	
	There are continuous crackling and hissing noises.	Noises result from lightning, fluorescent lamps, motors, thermostats and other electrical equipment.	Use an outdoor antenna and a ground wire. This will help somewhat, but it is difficult to eliminate all noise.	—	
			A TV set is being used nearby.	Move this unit away from the TV.	—
			The AM loop antenna is placed near the speaker cables.	Place the AM loop antenna away from the speaker cables.	—
There are buzzing and whining noises (especially in the evening).	The AM ANT and GND cords are inserted in the wrong terminal.	Make sure the white cord is inserted into the AM ANT terminal and the black cord into the GND terminal.	14		

■ Remote control

Problem	Cause	Remedy	Refer to page
The remote control does not work or function properly.	Wrong distance or angle.	The remote control will function within a maximum range of 6 m (20 ft) and no more than 30 degrees off-axis from the front panel.	6
	Direct sunlight or lighting (from an inverter type of fluorescent lamp, etc.) is striking the remote control sensor of this unit.	Reposition this unit.	—
	The batteries are weak.	Replace all batteries.	3
	The remote control code was not correctly set.	Set the remote control code correctly.	45
		Try to set the other codes of the same manufacturer.	45
Even if the remote control code is correctly set, some models may not respond to the remote control.			

GLOSSARY

Audio formats

■ Dolby Digital

Dolby Digital is a digital surround sound system that gives you completely independent multi-channel audio. With 3 front channels (left, center, and right), and 2 surround stereo channels, Dolby Digital provides 5 full-range audio channels. With an additional channel especially for bass effects, called LFE (low frequency effect), the system has a total of 5.1-channels (LFE is counted as 0.1 channel). By using 2-channel stereo for the surround speakers, more accurate moving sound effects and surround sound environment are possible than with Dolby Surround. The wide dynamic range (from maximum to minimum volume) reproduced by the 5 full-range channels and the precise sound orientation generated using digital sound processing provide listeners with previously unheard of excitement and realism.

With this unit, any sound environment from monaural up to a 5.1-channel configuration can be freely selected for your enjoyment.

■ Dolby Pro Logic II

Dolby Pro Logic II is an improved technique used to decode vast numbers of existing Dolby Surround software. This new technology enables a discrete 5-channel playback with 2 front left and right channels, 1 center channel, and 2 surround left and right channels (instead of only 1 surround channel for conventional Pro Logic technology). Music and Game modes are also available for 2-channel sources in addition to the Movie mode.

■ Dolby Surround

Dolby Surround uses a 4 channel analog recording system to reproduce realistic and dynamic sound effects: 2 front left and right channels (stereo), a center channel for dialog (monaural), and a surround channel for special sound effects (monaural). The surround channel reproduces sound within a narrow frequency range.

Dolby Surround is widely used with nearly all video tapes and laser discs, and in many TV and cable broadcasts as well. The Dolby Pro Logic decoder built into this unit employs a digital signal processing system that automatically stabilizes the volume on each channel to enhance moving sound effects and directionality.

■ DTS 96/24

DTS 96/24 offers an unprecedented level of audio quality for multi-channel sound on DVD-Video, and is fully backward-compatible with all DTS decoders. “96” refers to a 96 kHz sampling rate (compared to the typical 48 kHz sampling rate). “24” refers to 24-bit word length. DTS 96/24 offers sound quality transparent to the original 96/24 master, and 96/24 5.1-channel sound with full-quality full-motion video for music programs and motion picture soundtracks on DVD-video.

■ DTS (Digital Theater Systems) Digital Surround

DTS digital surround was developed to replace the analog soundtracks of movies with a 6-channel digital sound track, and is now rapidly gaining popularity in movie theaters around the world. Digital Theater Systems Inc. has developed a home theater system so that you can enjoy the depth of sound and natural spatial representation of DTS digital surround in your home. This system produces practically distortion-free 6-channel sound (technically, a left, right and center channels, 2 surround channels, plus an LFE 0.1 channel as a subwoofer, for a total of 5.1-channels). The unit incorporates a DTS-ES decoder that enables 6.1-channel reproduction by adding the surround back channel to existing 5.1-channel format.

Sound field programs

■ CINEMA DSP

Since the Dolby Surround and DTS systems were originally designed for use in movie theaters, their effect is best felt in a theater having many speakers and designed for acoustic effects. Since home conditions, such as room size, wall material, number of speakers, and so on, can differ so widely, it's inevitable that there are differences in the sound heard as well. Based on a wealth of actually measured data, YAMAHA CINEMA DSP uses YAMAHA original sound field technology to combine Dolby Pro Logic, Dolby Digital and DTS systems to provide the visual and audio experience of movie theater in the listening room of your own home.

■ SILENT CINEMA

YAMAHA has developed a natural, realistic sound effect DSP algorithm for headphones. Parameters for headphones have been set for each sound field so that accurate representations of all the sound field programs can be enjoyed on headphones.

■ Virtual CINEMA DSP

YAMAHA has developed a Virtual CINEMA DSP algorithm that allows you to enjoy DSP sound field surround effects even without any surround speakers by using virtual surround speakers. It is even possible to enjoy Virtual CINEMA DSP using a minimal two-speaker system that does not include a center speaker.

Audio information

■ ITU-R

ITU-R is the radio communication sector of the ITU (International Telecommunication Union). ITU-R recommends a standard speaker placement which is used in many critical listening rooms, especially for mastering purposes.

■ LFE 0.1 channel

This channel is for the reproduction of low bass signals. The frequency range for this channel is 20 Hz to 120 Hz. This channel is counted as 0.1 because it only enforces a low frequency range compared to the full-range reproduced by the other 5/6 channels in Dolby Digital or DTS 5.1/6.1-channel systems.

■ PCM (Linear PCM)

Linear PCM is a signal format under which an analog audio signal is digitized, recorded and transmitted without using any compression. This is used as a method of recording CDs and DVD audio. The PCM system uses a technique for sampling the size of the analog signal per very small unit of time. Standing for "pulse code modulation", the analog signal is encoded as pulses and then modulated for recording.

■ Sampling frequency and number of quantized bits

When digitizing an analog audio signal, the number of times the signal is sampled per second is called the sampling frequency, while the degree of fineness when converting the sound level into a numeric value is called the number of quantized bits.

The range of rates that can be played back is determined based on the sampling rate, while the dynamic range representing the sound level difference is determined by the number of quantized bits. In principle, the higher the sampling frequency, the wider the range of frequencies that can be played back, and the higher the number of quantized bits, the more finely the sound level can be reproduced.

Video signal information

■ **Composite video signal**

With the composite video signal system, the video signal is composed of three basic elements of a video picture; color, brightness and synchronization data. A composite video jack on a video component transmits these three elements combined.

SPECIFICATIONS

AUDIO SECTION

- Minimum RMS Output Power for Front, Center, Surround
[U.S.A and Canada models]
1 kHz, 0.9% THD, 6 Ω 65 W + 65 W (FTC)
[Other models]
1 kHz, 0.9% THD, 6 Ω 70 W + 70 W
- Maximum Power (EIAJ) for Front, Center, Surround
1 kHz, 10% THD, 6 Ω 100 W
- Input Sensitivity/Input Impedance
DVD/CD, etc. 200 mV/47 kΩ
- Output Level/Output Impedance
DVD/CD, etc. 200 mV/820 Ω
SUBWOOFER (FRONT SP: SMALL) 2.0 V/1.2 kΩ
- Headphone Jack Rated Output/Impedance
EXT IN (DVD/CD, etc.)
1 kHz 100 mV/100 Ω
- Frequency Response
Front (DVD/CD, etc.) 20 Hz to 50 kHz, 0/-3 dB
- Total Harmonic Distortion (FRONT SP OUT)
DVD/CD, etc. (Effect Off), 1 kHz, 35 W/6 Ω 0.04% or less
- Signal to Noise Ratio (IHF-A Network) (SP OUT)
DVD/CD, etc. (Effect Off), Input shorted, 250 mV
..... 100 dB or more
- Residual Noise (IHF-A Network)
SP OUT, Front L/R 150 μV or less
- Channel Separation (1 kHz/10 kHz)
DVD/CD, etc., Effect Off, VOL. -30 dB,
1 kHz/10 kHz, 5.1 kΩ terminated 60 dB/45 dB or more
- Tone Control Characteristics
[Bass]
Boost/Cut ±10 dB/60 Hz
[Treble]
Boost/Cut ±10 dB/20 kHz
- Filter Characteristics
FRONT, CENTER, SURROUND SP SMALL (H.P.F.)
..... fc = 40/60/80/90/100/110/120/160/200 Hz, 12 dB/oct.
SUBWOOFER (L.P.F.)
..... fc = 40/60/80/90/100/110/120/160/200 Hz, 24 dB/oct.

VIDEO SECTION

- Video Signal Type NTSC/PAL
- Video Signal Level 1 Vp-p/75 Ω
- Maximum Input Level 1.5 Vp-p
- Signal to Noise Ratio 50 dB or more
- Frequency Response (MONITOR OUT) 5 Hz to 10 MHz, -3 dB

FM SECTION

- Tuning Range
[U.S.A. and Canada models] 87.5 to 107.9 MHz
[Asia and General models] 87.5/87.50 to 108.0/108.00 MHz
[Other models] 87.50 to 108.00 MHz
- Quieting Sensitivity (IHF)
Mono (50 dB, 1 kHz, 100% MOD.) 2.8 μV (20.2 dBf)
- Signal to Noise Ratio (IHF)
Mono/Stereo 73 dB/70 dB
- Harmonic Distortion (1 kHz)
Mono/Stereo 0.5%/0.5%
- Antenna Input 75 Ω unbalanced

AM SECTION

- Tuning Range
[U.S.A. and Canada models] 530 to 1710 kHz
[Asia and General models] 530/531 to 1710/1611 kHz
[Other models] 531 to 1611 kHz
- Antenna Loop antenna

GENERAL

- Power Supply
[U.S.A. and Canada models] AC 120 V, 60 Hz
[Australia model] AC 240 V, 50 Hz
[China model] AC 220 V, 50 Hz
[Korea model] AC 220 V, 60 Hz
[U.K. and Europe models] AC 230 V, 50 Hz
[Asia model] AC 220-240 V, 50/60 Hz
[General model] AC 110-120 V, 50/60 Hz
- Power Consumption 90 W
- Standby Power Consumption
[U.S.A., Canada and General models] 0.8 W
[U.K. and Europe models] 0.9 W/2.5 W
[Other models] 0.9 W
- Dimension (W x H x D) 435 x 55.5 x 325 mm
(17-1/8" x 2-3/16" x 12-3/4")
- Weight 6.4 kg
(14 lbs 2 oz.)

LIST OF REMOTE CONTROL CODES

TV

YAMAHA 299, 292
 ADMIRAL 292, 293
 AIWA 294, 276, 283, 284
 AKAI 295, 296
 ALBA 296
 AOC 297
 BELL&HOWELL 292
 BESTAR 298
 BLAUPUNKT 229, 222
 BLUE SKY 298
 BRANDT 223
 BROCSONIC 297
 BUSH 296
 CLATRONIC 298
 CRAIG 224
 CROSLEX 225
 CURTIS MATHIS 297, 226
 DAEWOO 297, 298, 224, 227, 228
 DAYTRON 239
 DUAL 298
 EMERSON 297, 224, 239, 232
 FERGUSON 223, 265, 266
 FIRST LINE 298
 FUNAI 277, 278
 FISHER 295, 233
 FRABA 298
 GE 293, 297, 234, 235, 236
 LG/GOLDSTAR 297, 298, 239, 237
 GOODMANS 296, 298, 223
 GRUNDIG 229, 238, 249
 HITACHI 297, 239, 242, 243, 285
 ICE 296
 IRRADIO 296
 ITT/NOKIA 244, 245
 JC PENNY 293, 297, 234, 237
 JVC 296, 246, 247, 286
 KENDO 298
 KTV 297, 239
 LOEWE 298, 248
 LXI 293, 297, 225, 226, 233
 MAGNAVOX 297, 225, 239
 MATSUI 295
 MITSUBISHI 299, 297, 259, 287
 NEC 297, 252, 282

NOKIA 244, 245
 NOKIA OCEANIC 245
 NORDMENDE 265, 266
 ONWA 296
 PANASONIC 234, 235, 236, 253, 288, 211
 PHILCO 297, 225, 239
 PHILIPS 225
 PIONEER 226, 235, 254, 255, 268
 PORTLAND 297, 256
 QUASAR 234, 235
 RADIO SHACK 299, 293, 297
 RCA 293, 297, 234, 256, 257, 258
 SABA 223, 269, 265, 266
 SAMSUNG 297, 239, 248, 262, 275
 SANYO 295, 233, 279, 272, 273, 274, 212
 SCHNEIDER 296
 SCOTT 297
 SHARP 292, 239, 232, 213, 216
 SIEMENS 229
 SIGNATURE 292
 SONY 263, 214
 SYLVANIA 297, 225
 TELEFUNKEN 269, 264, 265, 266
 THOMSON 223, 266
 TOSHIBA 292, 226, 267, 215
 VIDECH 297, 242
 WARDS 297, 239, 232

VCR

YAMAHA 399, 392, 393, 394
 ADMIRAL 395
 AIWA 396, 397, 398, 329, 339
 AKAI 322, 323, 324
 AUDIO DYNAMIC 392, 394
 BELL&HOWELL 393
 BLAUPUNKT 325, 326
 BROCSONIC 327
 BUSH 322
 CANON 325, 328
 CGM 396, 332
 CITIZEN 396
 CRAIG 396

CURTIS MATHIS 397, 328, 333
 DAEWOO 3328, 334, 335
 DBX 3392, 394
 DIMENSIA 333
 EMERSON 327, 334
 FISHER 393, 336
 FUNAI 397
 GE 328, 333, 387
 LG/GOLDSTAR 396, 388
 GOODMANS 334, 337
 GRUNDIG 332, 338
 HITACHI 325, 333, 349, 342, 343
 INSTANT REPLAY 325, 328
 ITT/NOKIA 393
 JC PENNY 392, 393, 394, 328, 333, 349
 JVC 392, 394, 344, 345, 346, 347
 KENDO 396
 KENWOOD 392, 394, 396
 LOEWE 396, 337
 LUXOR 395
 LXI 393, 396, 397, 336, 349
 MAGNAVOX 325, 326, 328
 MARANTZ 392, 394
 MARTA 396
 MATSUI 396
 MEMOREX 328, 336
 MINOLTA 333, 349
 MITSUBISHI 399, 344, 348, 359, 352, 353
 MULTITECH 397, 348, 354
 NEC 392, 394, 344, 383, 393, 395
 NOKIA 395
 NOKIA OCEANIC 323
 OKANO 325, 328
 OLYMPIC 327
 ORION 325, 328, 339, 355, 378, 384, 385, 386
 PANASONIC 333, 349
 PHILCO 325, 328
 PHILIPS 325, 326, 328, 337, 356, 357
 PHONOLA 337
 PIONEER 325
 QUASAR 325, 328
 RCA/PROSCAN 325, 326, 328, 333, 335, 349, 358, 369

REALISTIC 393, 397, 328, 336, 359, 362
 SAMSUNG 354, 358, 363, 364, 365, 366
 SANSUI 394
 SANYO 393, 336, 367
 SCHNEIDER 337
 SCOTT 399, 335, 336, 348, 359, 352, 354, 358
 SELECO 322
 SHARP 395, 362, 382
 SIEMENS 393
 SIGNATURE 2000 395, 397
 SONY 368, 379, 372, 373, 374, 375
 SYLVANIA 397, 325, 326, 328
 SYMPHONIC 397
 TANDBERG 334
 TASHIRO 396
 TATUNG 392, 394
 TEAC 392, 394, 397
 TECHNICS 325, 328
 TELEFUNKEN 376, 377
 THORN 393, 396
 TOSHIBA 335, 369, 389
 UNIVERSUM 396, 327, 376
 W.WHOUSE 396
 WARDS 395, 396, 336, 362

DVD

YAMAHA 699, 622, 623
 DENON 623, 624
 FUNAI 625
 HITACHI 626
 JVC 627
 KENWOOD 628
 MITSUBISHI 629
 ONKYO 632, 633, 634
 PANASONIC 623, 635
 PHILIPS 699, 647
 PIONEER 636, 637, 638
 RCA 639
 SAMSUNG 642
 SHARP 643
 SONY 644
 TOSHIBA 634, 648, 649
 LG/GOLD STAR 645
 THOMSON 646



This product mainly uses lead-free solder.

© 2004 YAMAHA CORPORATION All rights reserved.

YAMAHA ELECTRONICS CORPORATION, USA 6660 ORANGETHORPE AVE., BUENA PARK, CALIF. 90620, U.S.A.
YAMAHA CANADA MUSIC LTD. 135 MILNER AVE., SCARBOROUGH, ONTARIO M1S 3R1, CANADA
YAMAHA ELECTRONIK EUROPA G.m.b.H. SIEMENSSTR. 22-34, 25462 RELINGEN BEI HAMBURG, F.R. OF GERMANY
YAMAHA ELECTRONIQUE FRANCE S.A. RUE AMBROISE CROIZAT BP70 CROISSY-BEAUBOURG 77312 MARNE-LA-VALLEE CEDEX02, FRANCE
YAMAHA ELECTRONICS (UK) LTD. YAMAHA HOUSE, 200 RICKMANSWORTH ROAD WATFORD, HERTS WD18 7GQ, ENGLAND
YAMAHA SCANDINAVIA A.B. J A WETTERGRENS GATA 1, BOX 30053, 400 43 VÄSTRA FRÖLUNDA, SWEDEN
YAMAHA MUSIC AUSTRALIA PTY, LTD. 17-33 MARKET ST., SOUTH MELBOURNE, 3205 VIC., AUSTRALIA

YAMAHA CORPORATION
Printed in Malaysia  WD87150